

Divyakash Group
ARCHITECTURAL, INTERIOR, PLANNING CONSULTANTS

KEY PLAN:

NORTH:

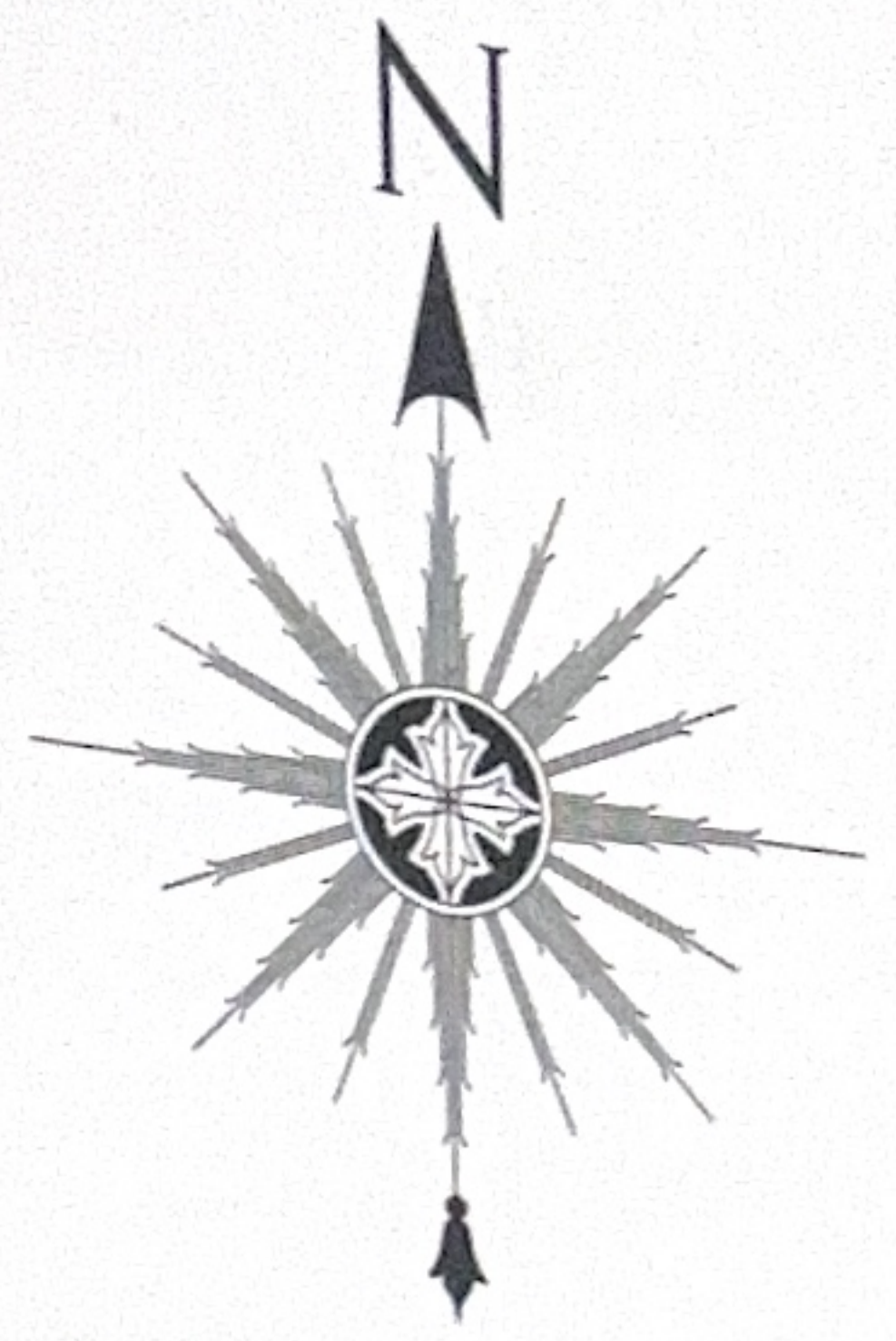

NOTES:-

1. THIS IS A CONCEPTUAL DRAWING NOT FOR CONSTRUCTION
2. ALL DIMENSIONS ARE IN FT/INCH
ONLY NOTED DIMENSION SHALL BE FOLLOWED.

क. सं. 17225 / SN/02/07/102
 गण सं. 2793/16/14/0201/0202/2023
 14461-2666/15/11/2023/2731-2741/1668
 विकसित क्षेत्र 36 हे.क.
 दि. 17/11/2025

Ravi Kumar
 Consulting Engineer
 Panchayati Raj Department
 Haridwar UP

REV	DESCRIPTION	DATE	DRN	CHK	APP

PURPOSE OF DRAWING -
**Topographical Survey Plan At
 GARH MUKTESHWAR**

CLIENT:
LONAR GROUP

LOCATION:
GARH MUKTESHWAR

ARCHITECT:
DIVYAKASH ATELIER INC
 ARCHITECTURAL, INTERIOR, PLANNING CONSULTANTS
 A VENTURE OF DIVYAKASH GROUP
 # 407, ORBIT PLAZA, CROSSING REPUBLIC,
 GHAZIABAD
 CONTACT US - +91- 9999809559
 E mail- groupdivyakash@gmail.com

SHEET TITLE:
PLOT DETAIL

NAME	DATE	SIGN
DRAWN BY		
CHECKED BY	AD	
APPROVED BY		
PROJECT No.		SHEET SIZE A3
ISSUE DATE	8.5.25	SCALE N.T.S.
SHEET No.		REV No. R0





Divyakash Group
ARCHITECTURAL INTERIOR PLANNING CONSULTANTS

KEY PLAN:

NORTH

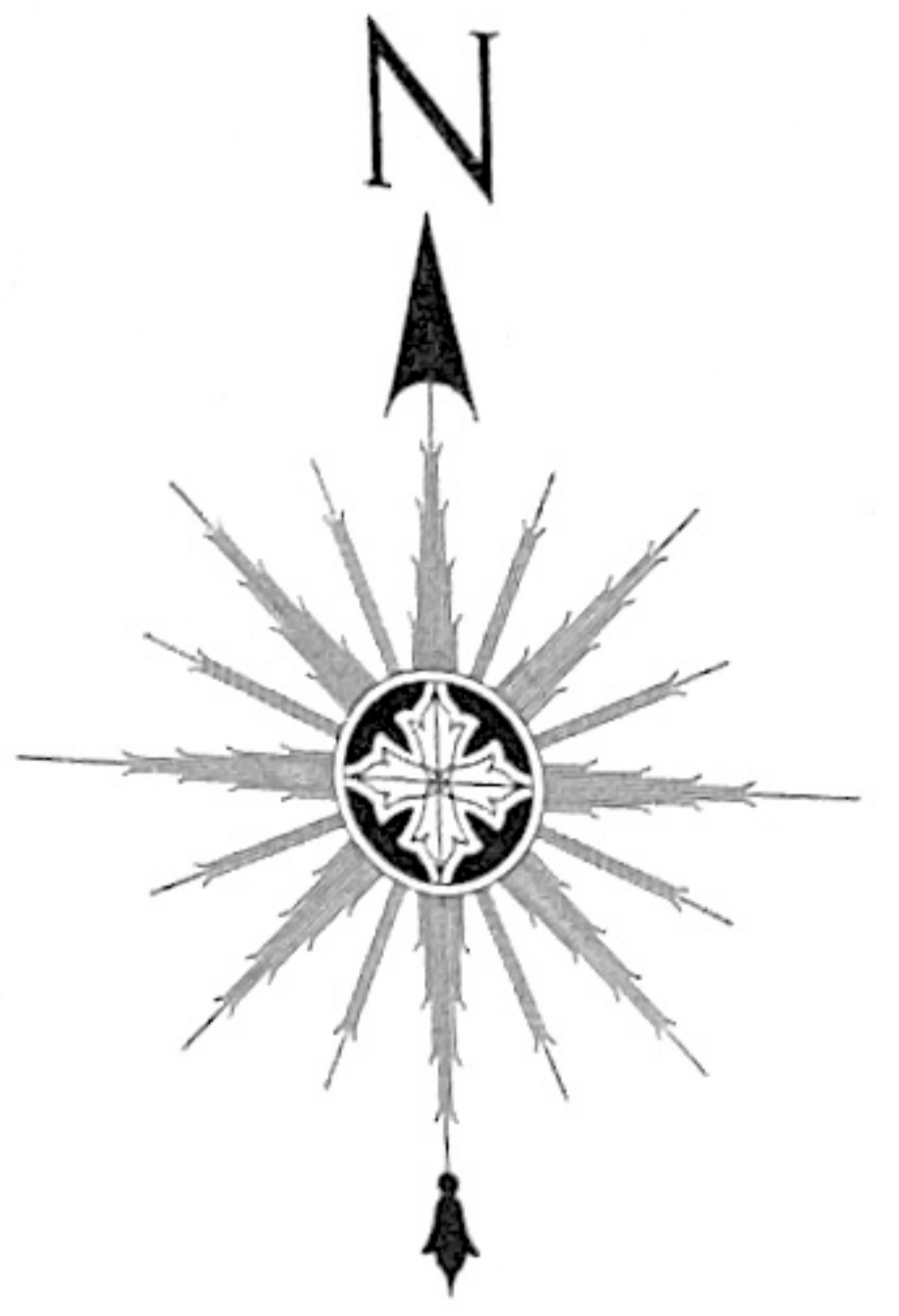

NOTES:-

1. THIS IS A CONCEPTUAL DRAWING NOT FOR CONSTRUCTION
 2. ALL DIMENSIONS ARE IN FT/INCH
- ONLY NOTED DIMENSION SHALL BE FOLLOWED.

क्र. सं. 17225/SN/02/07/12/25
 गण सं. 2793/11/14/2025/2821/2874/2023
 144612060/1579/2023/2773/2794/1608
 विकसित क्षेत्र 36.00 अ.से.
 दि. 17/11/2025

Raj Kumar
 Consulting Engineer
 Panchayati Raj Department
 Hapur UP

REV	DESCRIPTION	DATE	LOGN	CRN	CHK	APP

PURPOSE OF DRAWING :-

Topographical Survey Plan At
GARH MUKTESHWAR

CLIENT:

LONAR GROUP

LOCATION:

GARH MUKTESHWAR

ARCHITECT:

DIVYAKASH ATELIER INC
ARCHITECTURAL INTERIOR PLANNING CONSULTANTS

A VENTURE OF DIVYAKASH GROUP
 # 407, ORBIT PLAZA, CROSSING REPUBLIK,
 GHAZIABAD
 CONTACT US - +91- 9999609559
 E mail- groupdivyakash@gmail.com

SHEET TITLE:

PLOT DETAIL

NAME	DATE	SIGN
DRAWN BY		
CHECKED BY	AD	
APPROVED BY		
PROJECT No.		SHEET SIZE A3
ISSUE DATE	05.28	SCALE N.T.S
SHEET No.		REV No. R0





Divyakash Group
ARCHITECTURAL INTERIOR PLANNING CONSULTANTS

KEY PLAN

NORTH

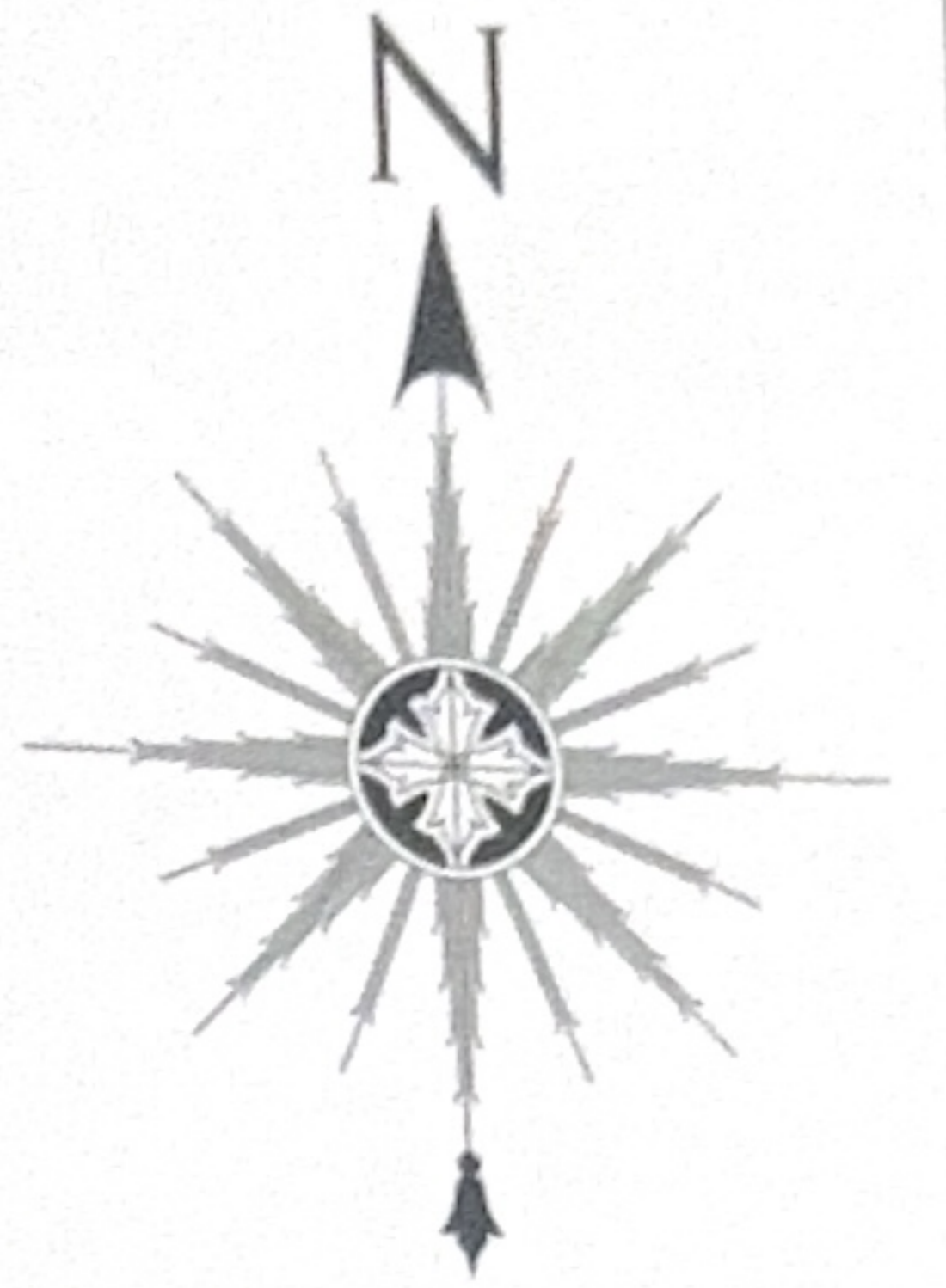

NOTES:-

- 1. THIS IS A CONCEPTUAL DRAWING NOT FOR CONSTRUCTION
 - 2. ALL DIMENSIONS ARE IN FT/INCH
- ONLY NOTED DIMENSION SHALL BE FOLLOWED.

क.सं. 17225/SN/02/07/12/25
 गा.सं. 2743/11/14/2024/2023/2024/2023
 144612060/1590/2023/2743/2743/1668
 51 ACYC
 विकसित क्षेत्र 36 Acre
 दि. 17/11/2025

Ravi Kumar
 Consulting Engineer
 Panchayati Raj Department
 Hapur UP

REV	DESCRIPTION	DATE	DDN	CHK	APP

PURPOSE OF DRAWING :-
 Topographical Survey Plan At
 GARH MUKTESHWAR

CLIENT: LONAR GROUP

LOCATION: GARH MUKTESHWAR



ARCHITECT:
DIVYAKASH ATELIER INC
 ARCHITECTURAL INTERIOR PLANNING CONSULTANTS
 A VENTURE OF DIVYAKASH GROUP
 # 407, ORBIT PLAZA, CROSSING REPUBLIK,
 GHAZIABAD
 CONTACT US - +91-9999809559
 E mail- groupdivyakash@gmail.com

SHEET TITLE: PLOT DETAIL

NAME	DATE	SIGN
DRAWN BY		
CHECKED BY	AD	
APPROVED BY		
PROJECT No		SHEET SIZE A3
ISSUE DATE	03.25	SCALE N.T.S.
SHEET No		REV No

RO





Divyakash Group
ARCHITECTURAL INTERIOR PLANNING CONSULTANTS

KEY PLAN

NORTH

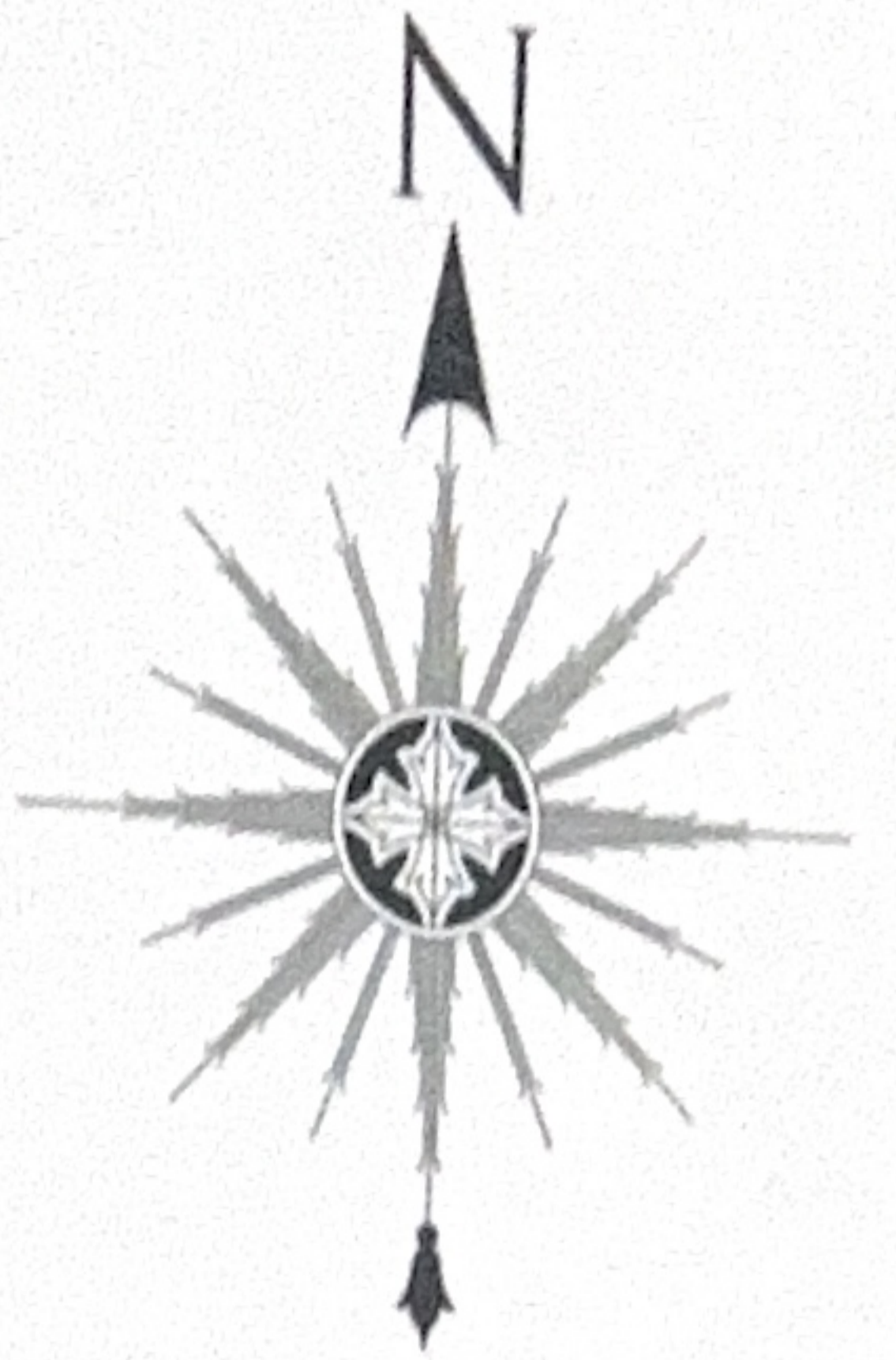

NOTES:-

1. THIS IS A CONCEPTUAL DRAWING NOT FOR CONSTRUCTION
 2. ALL DIMENSIONS ARE IN FT/INCH
- ONLY NOTED DIMENSION SHALL BE FOLLOWED.

क. सं. 13225/15/10/10/11/2025
 गा. सं. 2744/16/1/2029/203/12024/2023
 1446/206/1594/203/12993/160/1
 57 ACY
 वि. सं. 36 ACY
 दि. 17/11/2025

Raj Kumar
Consulting Engineer
Panchayati Raj Department
Hapur UP

REV	DESCRIPTION	DATE	DOA	CRN	CHK	APP

PURPOSE OF DRAWING :-

Topographical Survey Plan At
GARH MUKTESHWAR

CLIENT

LONAR GROUP

LOCATION

GARH MUKTESHWAR

ARCHITECT

DIVYAKASH ATELIER INC
ARCHITECTURAL INTERIOR PLANNING CONSULTANTS
A VENTURE OF DIVYAKASH GROUP
407, ORBIT PLAZA, CROSSING REPUBLIC,
GHAZIABAD
CONTACT US - +91- 9999609559
E mail- groupdivyakash@gmail.com

SHEET TITLE

BLOCK DIMENSION DETAIL

NAME	DATE	SIGN
DRAWN BY		
CHECKED BY	AD	
APPROVED BY		
PROJECT No.		SHEET SIZE
ISSUE DATE	6.5.25	SCALE
SHEET No.		REV No.

R 0



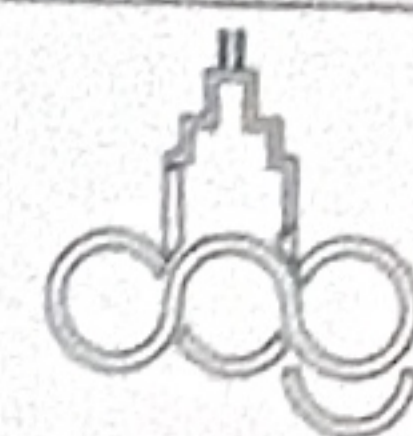

Divyakash Group
ARCHITECTURAL INTERIOR PLANNING CONSULTANTS

KEY PLAN

NORTH

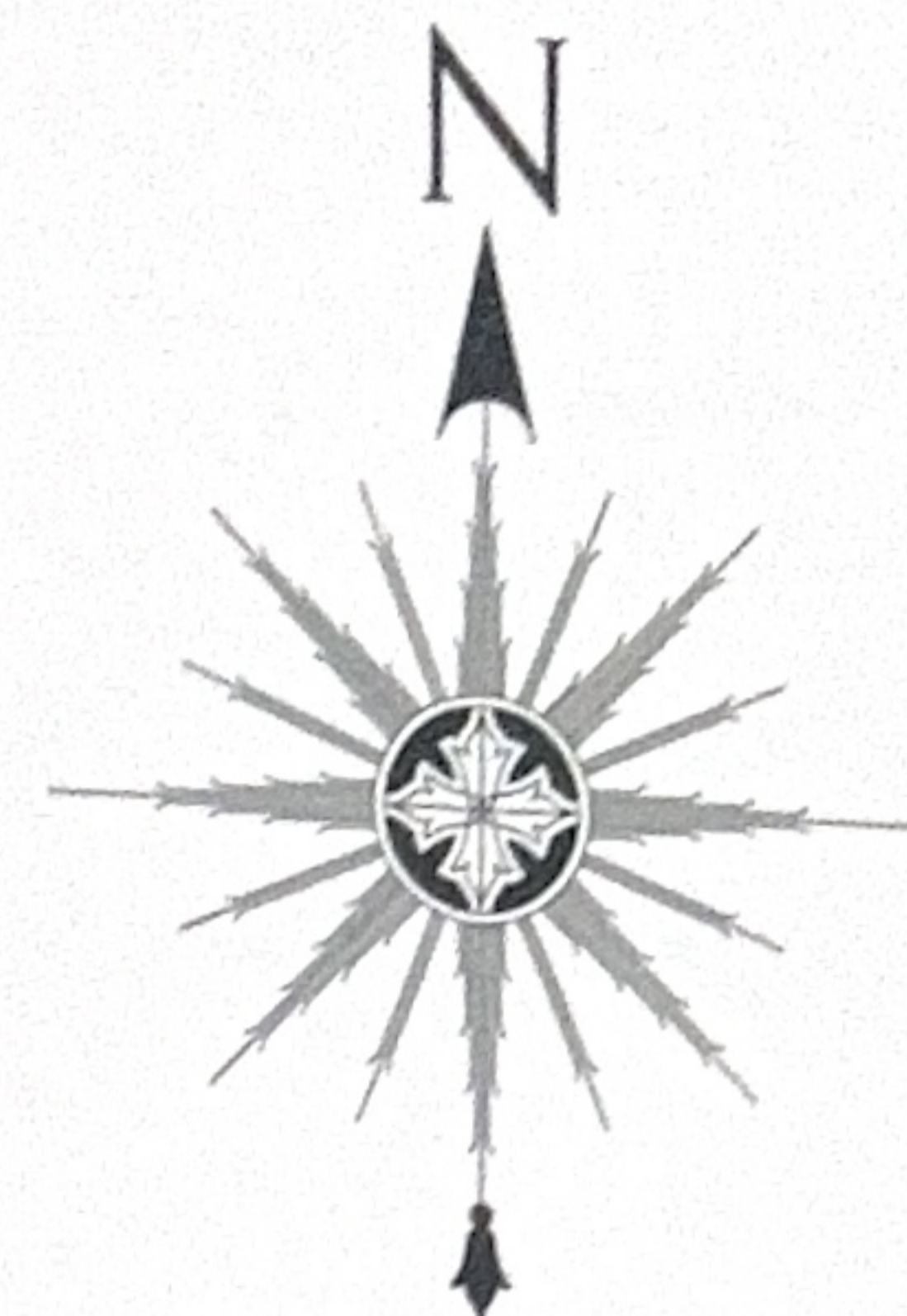

NOTES:-

1. THIS IS A CONCEPTUAL DRAWING NOT FOR CONSTRUCTION
 2. ALL DIMENSIONS ARE IN FT/INCH
- ONLY NOTED DIMENSION SHALL BE FOLLOWED.

क्र. 17-225/51162/07.11.2025
 77/201/2744/11/14/2029/2032/2036/4003
 146/12066/1594/209/2733/2799/1600
 51 Acre
 विकसित क्षेत्र 36 Acre
 दि. 17/11/2025

Ravi Kumar
 Consulting Engineer
 Panchayat Health Department
 Hapur UP

REV	DESCRIPTION	DATE	DDN	DRN	CHK	APP
-----	-------------	------	-----	-----	-----	-----

PURPOSE OF DRAWING :-
**Topographical Survey Plan At
 GARH MUKTESHWAR**

CLIENT:
LONAR GROUP

LOCATION:
GARH MUKTESHWAR

ARCHITECT:
DIVYAKASH ATELIER INC
 ARCHITECTURAL INTERIOR PLANNING CONSULTANTS
 A VENTURE OF DIVYAKASH GROUP
 # 407, ORBIT PLAZA, CROSSING REPUBLIK,
 GHAZIABAD
 CONTACT US - +91-9999609559
 E mail- groupdivyakash@gmail.com

SHEET TITLE:
PLOT DIMENSION DETAIL

NAME	DATE	SIGN
DRAWN BY		
CHECKED BY	AD	
APPROVED BY		
PROJECT No.		SHEET SIZE A3
ISSUE DATE	8.5.25	SCALE N.T.S.
SHEET No.		REV. No.



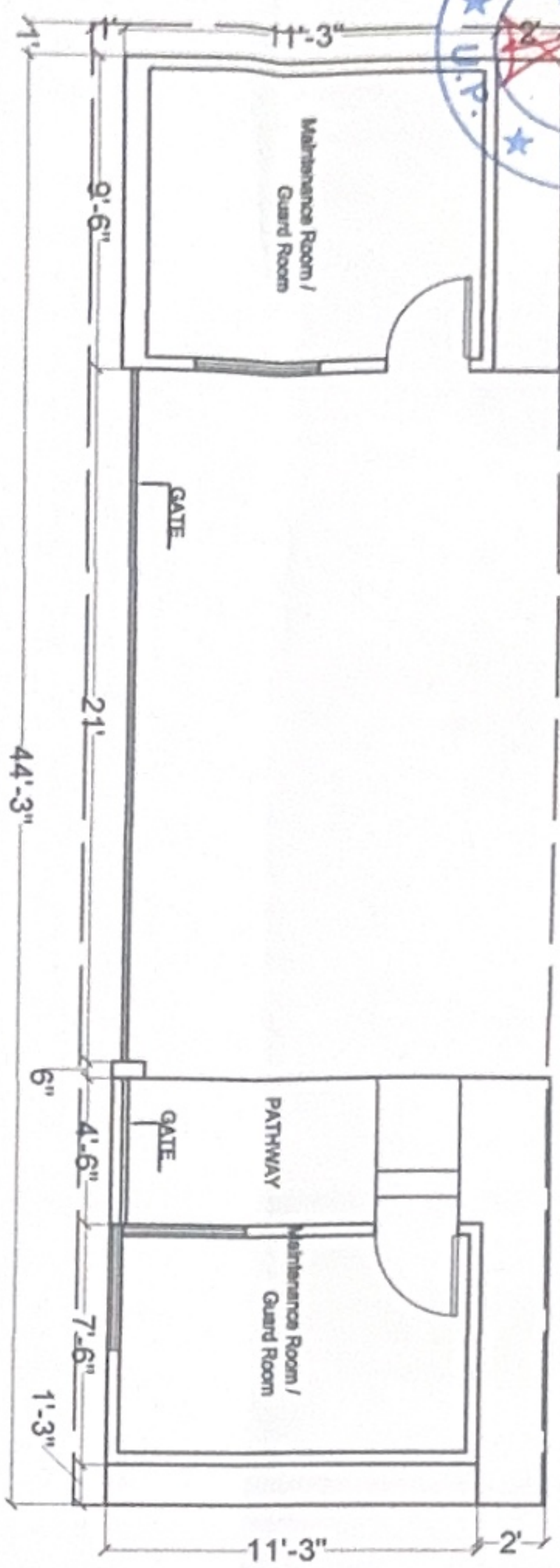

PLAN

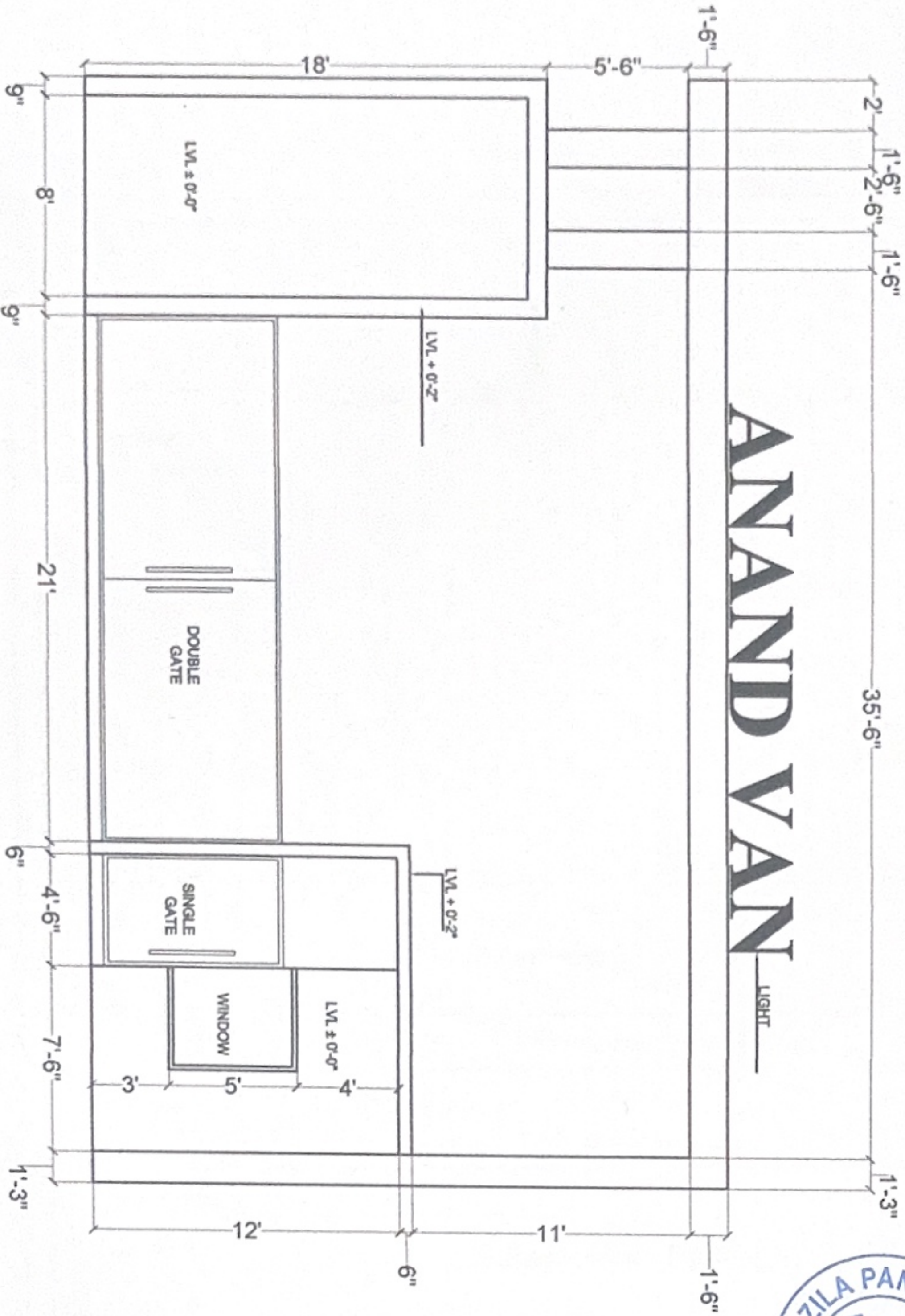

ELEVATION

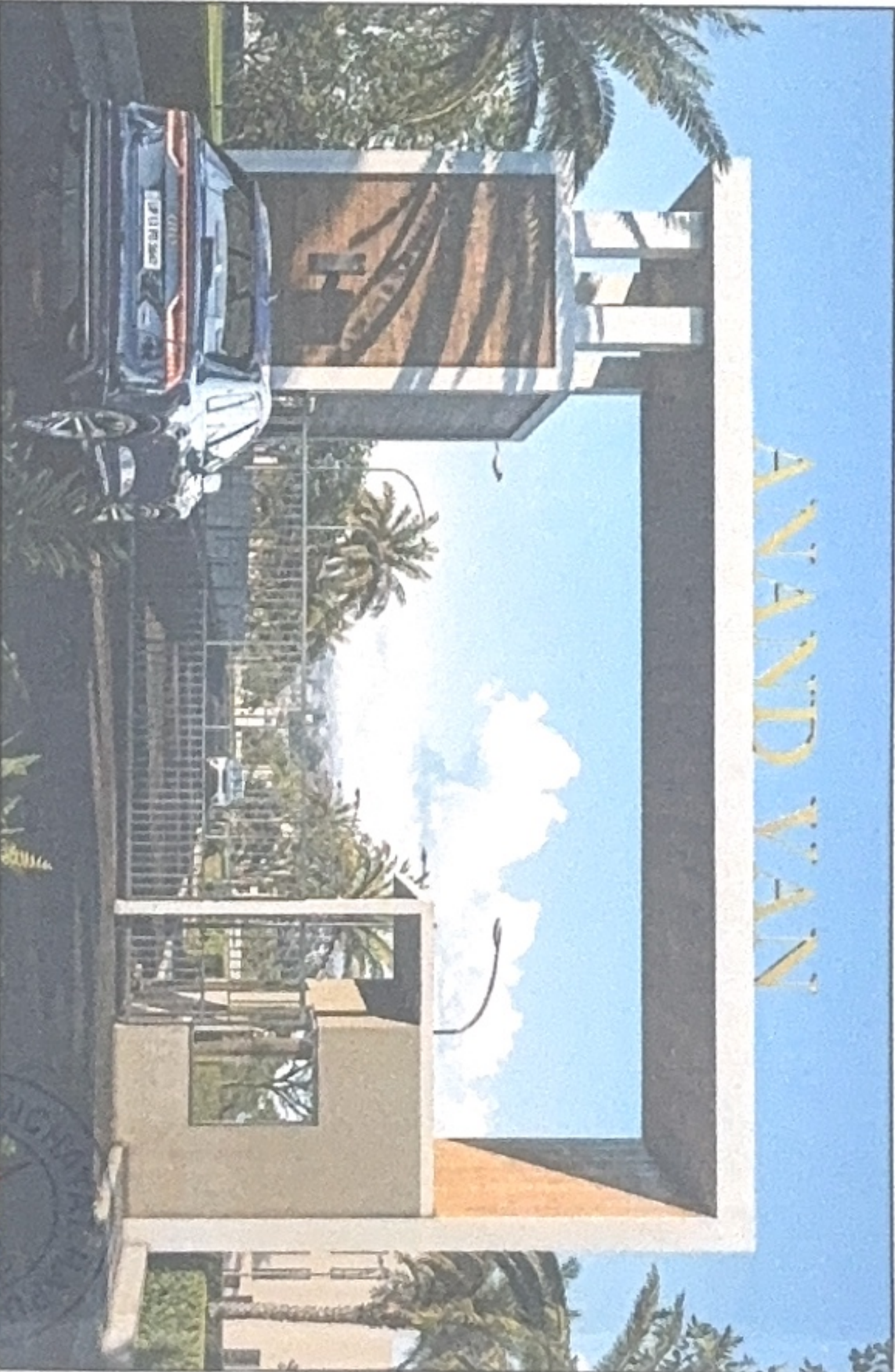

Logo and name of Divyakash Group Architectural, Interior Planning Consultants.

NOTES: 1. THIS IS A CONCEPTUAL DRAWING NOT FOR CONSTRUCTION 2. ALL DIMENSIONS ARE IN FEET AND INCH ONLY MATED DIMENSION SHALL BE FOLLOWED.

Signature and name of Rajiv Kumar, Consulting Engineer, Panchayati Raj Department Hapur UP.

Table with project details including sheet title (MAIN GATE), architect (DIVYAKASH ATELLER INC), location (GARH MUKTESHWAR), and drawing type (STRUCTURE DRAWING).

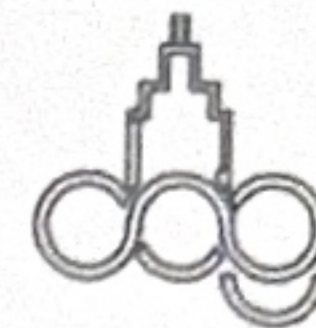

Divyakash Group
ARCHITECTURAL INTERIOR PLANNING CONSULTANTS

KEY PLAN

NORTH

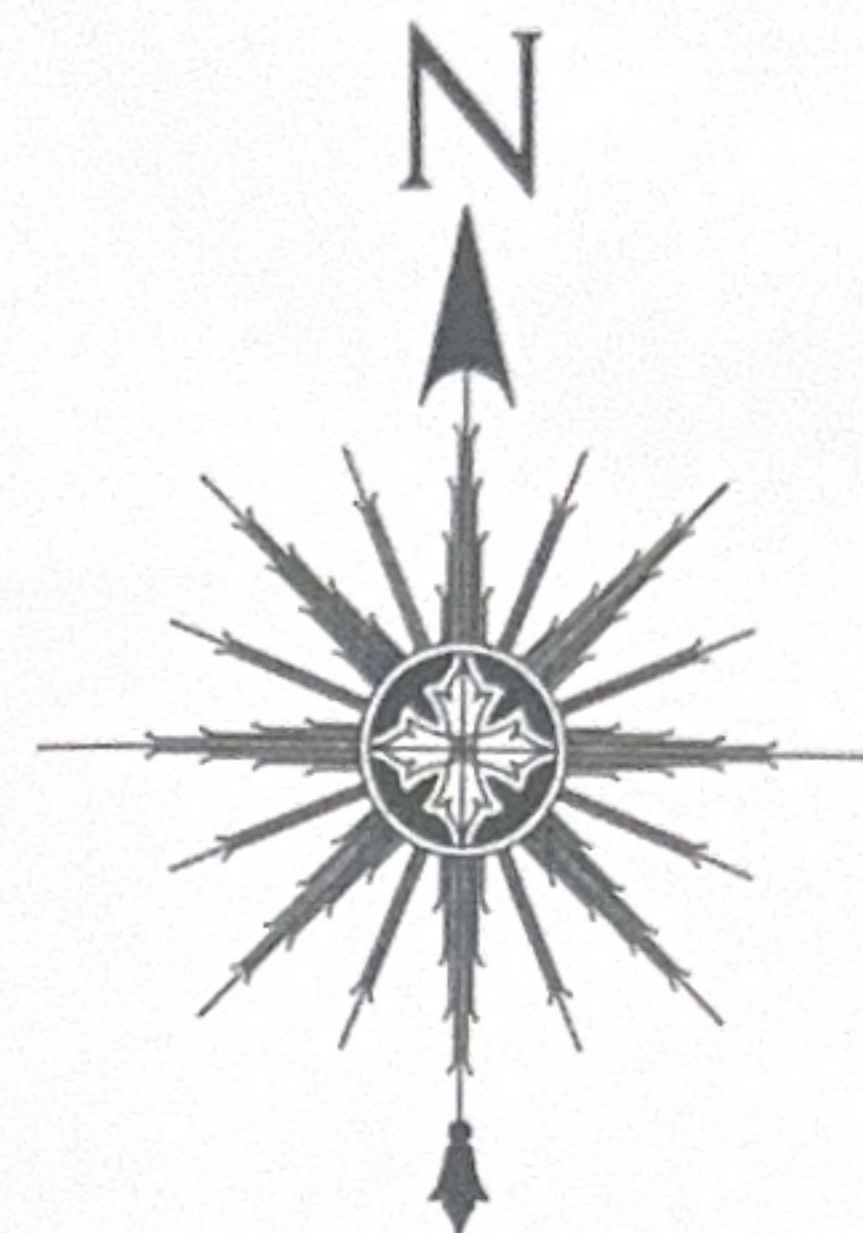

NOTES:-

1. THIS IS A CONCEPTUAL DRAWING NOT FOR CONSTRUCTION
 2. ALL DIMENSIONS ARE IN FT.INCH
- ONLY NOTED DIMENSION SHALL BE FOLLOWED.

Flavi Kumar
Consulting Engineer
Panchayati Raj Department
Hapur UP

REV	DESCRIPTION	DATE	CON	CHK	APP
-----	-------------	------	-----	-----	-----

PURPOSE OF DRAWING :-

Topographical Survey Plan At
GARH MUKTESHWAR

CLIENT



LOCATION

GARH MUKTESHWAR

ARCHITECT

DIVYAKASH ATELIER INC
ARCHITECTURAL INTERIOR PLANNING CONSULTANTS
A VENTURE OF DIVYAKASH GROUP
407, ORBIT PLAZA, CROSSING REPUBLIK,
GHAZIABAD
CONTACT US - +91- 9999609559
E mail- groupdivyakash@gmail.com

SHEET TITLE

Studio

NAME	DATE	SIGN
DRAWN BY		
CHECKED BY	AD	
APPROVED BY		
PROJECT No.		SHEET SIZE
ISSUE DATE	11.25	SCALE
SHEET No.		REV. No.

R0

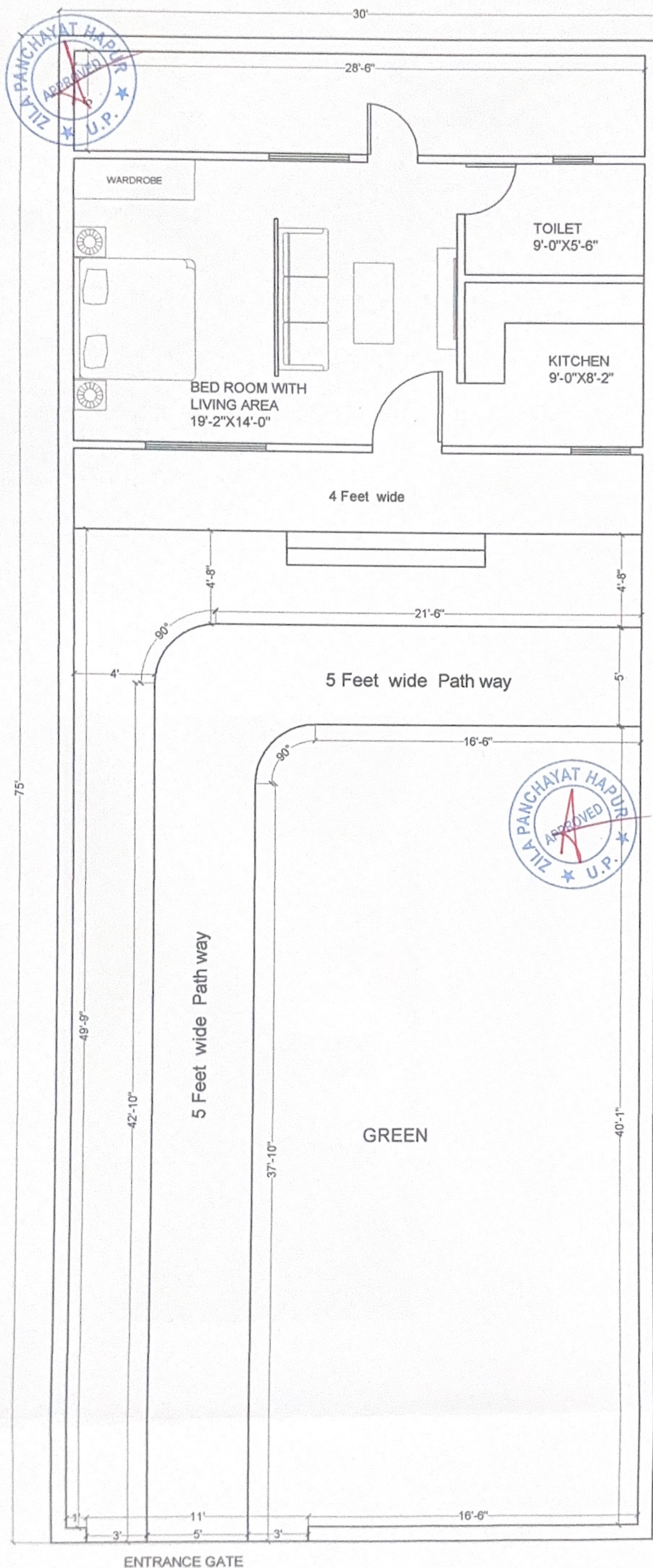

AREA :- 494.91 sqft

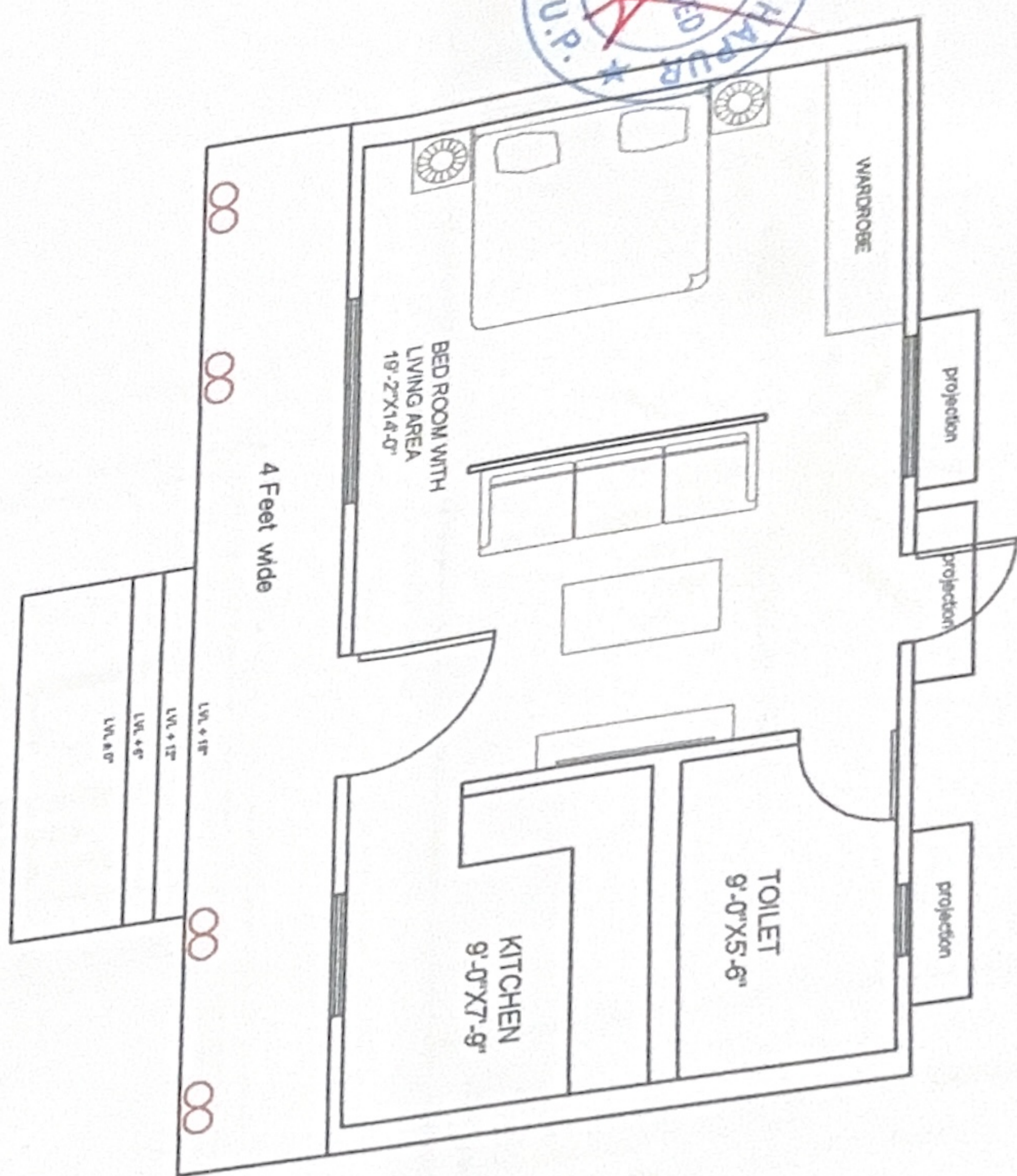

PLAN DETAIL

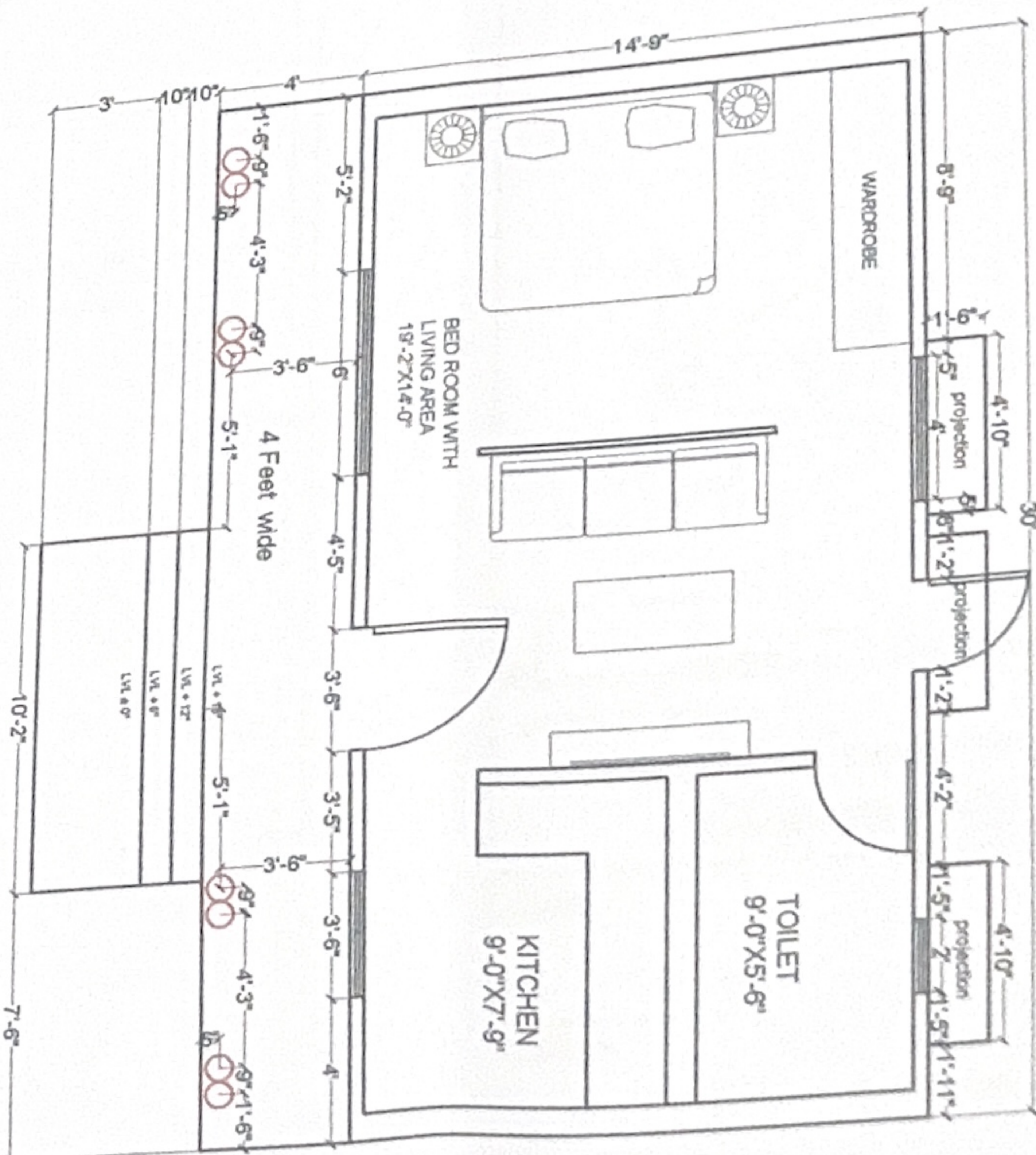

PLAN DETAIL

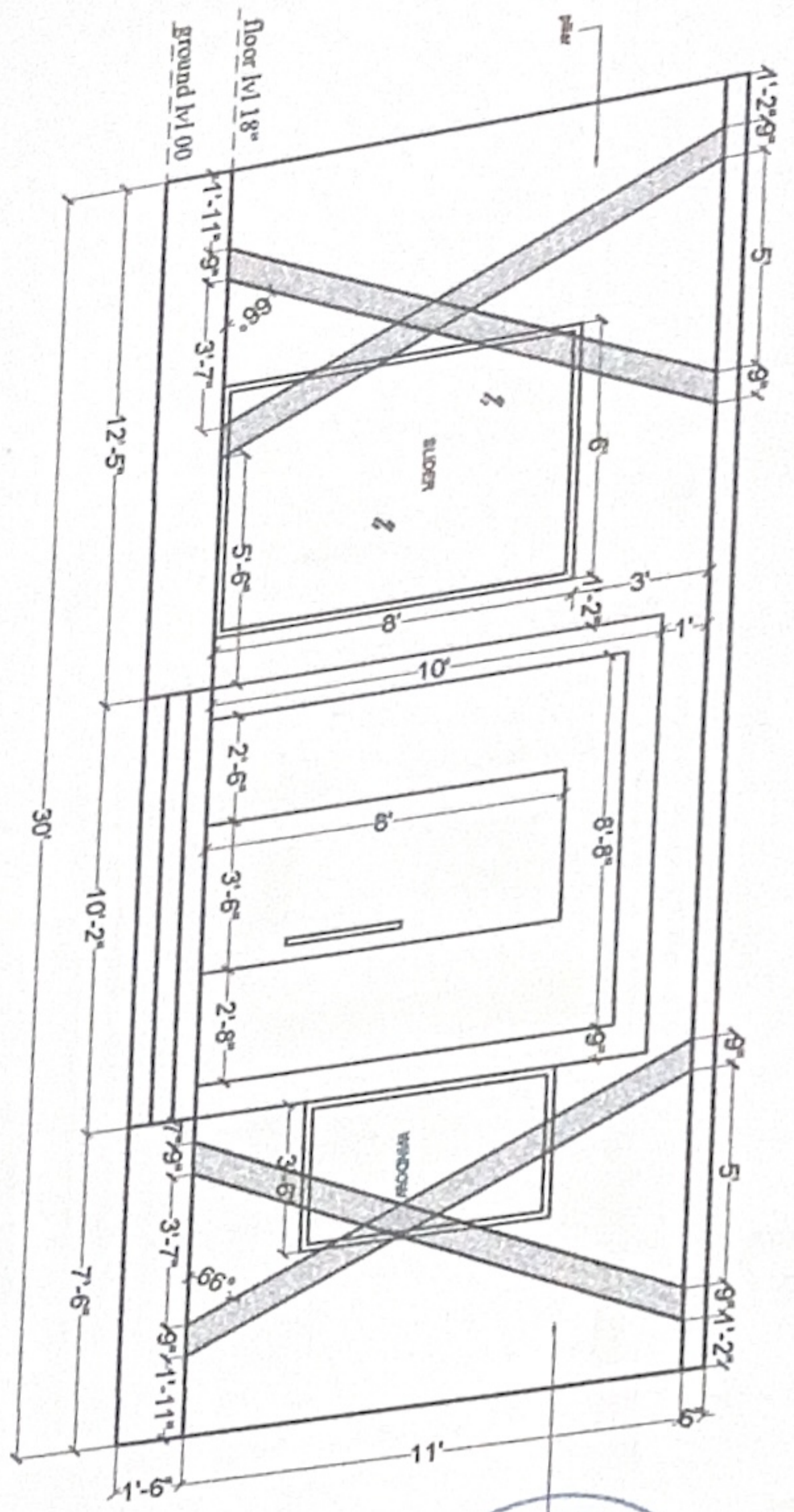

ELEVATION

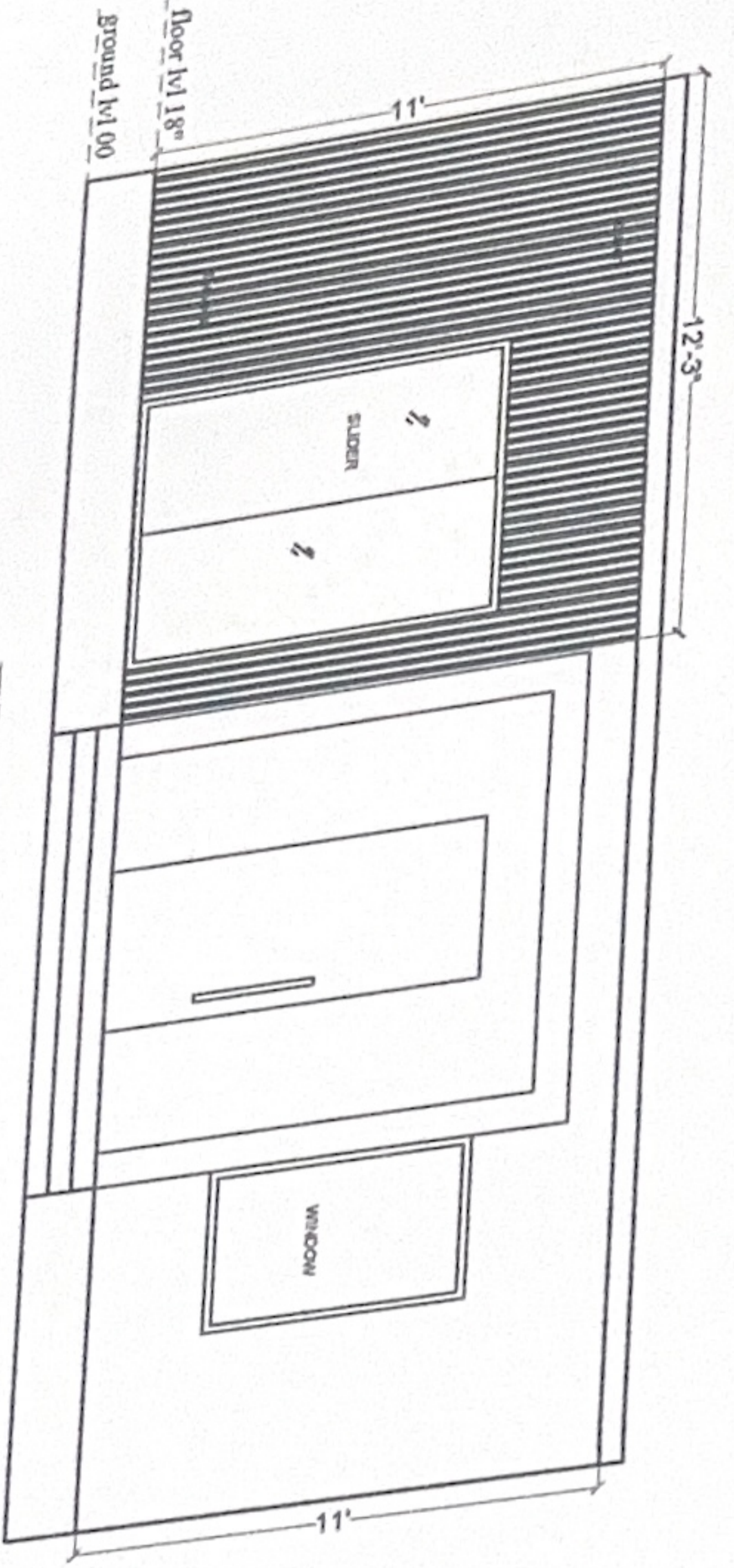

ELEVATION



Divyakash Group
ARCHITECTURAL, INTERIOR PLANNING CONSULTANTS

NOTES:-
1. THIS IS A CONCEPTUAL DRAWING NOT FOR CONSTRUCTION
2. ALL DIMENSIONS ARE IN FEET/INCH
ONLY NORTH DIRECTION SHALL BE FOLLOWED.

Consulting Engineer
Raj Panchayati Raj Department
Hapur UP

PROJECT TITLE	STUDIO
ARCHITECT	DIVYAKASH ATELIER INC
LOCATION	GARH MUKTESHWAR
CLIENT	
DATE	
SCALE	
SHEET NO.	AA
TOTAL SHEETS	R0



Divyakash Group
ARCHITECTURAL . INTERIOR . PLANNING CONSULTANTS

KEY PLAN

NORTH

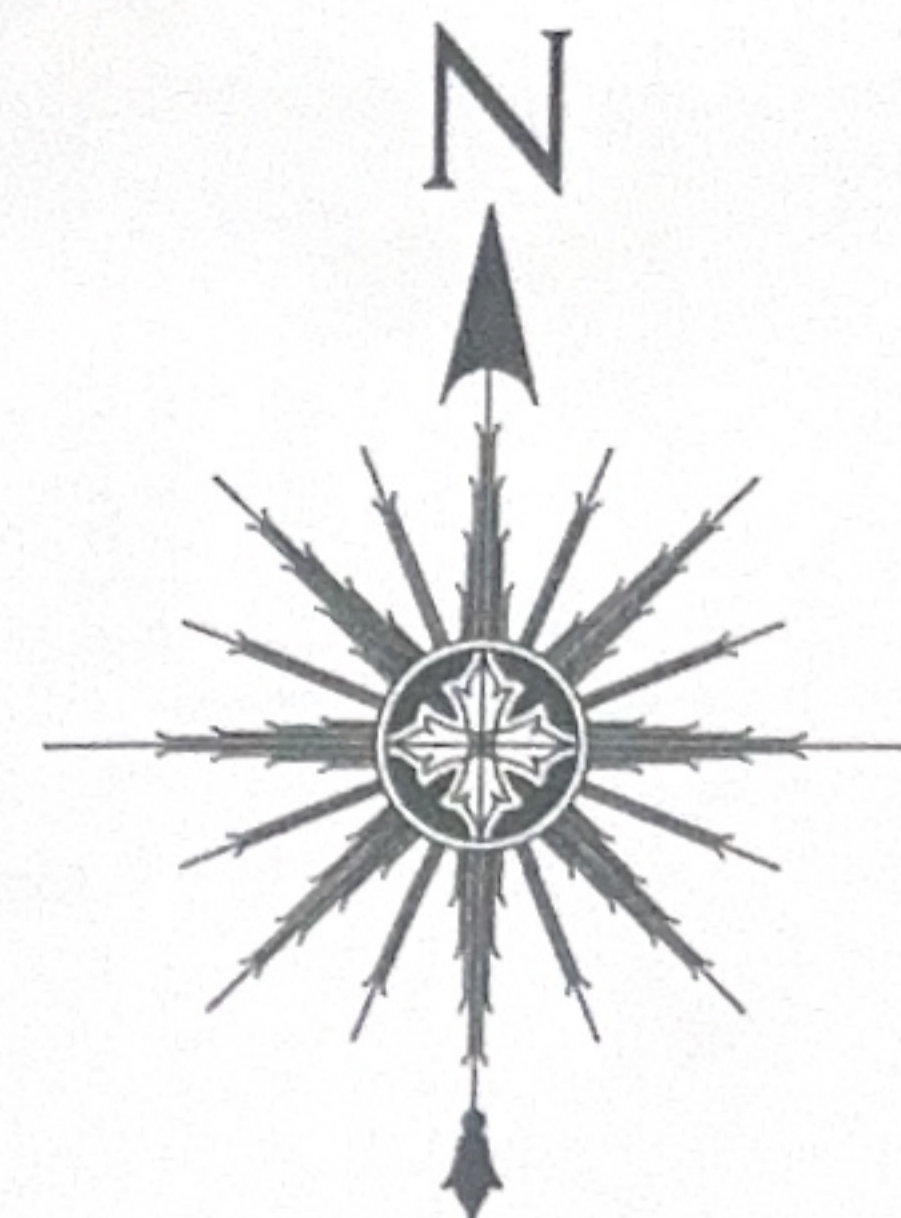

NOTES:-

1. THIS IS A CONCEPTUAL DRAWING NOT FOR CONSTRUCTION
2. ALL DIMENSIONS ARE IN FT.INCH
ONLY NOTED DIMENSION SHALL BE FOLLOWED.

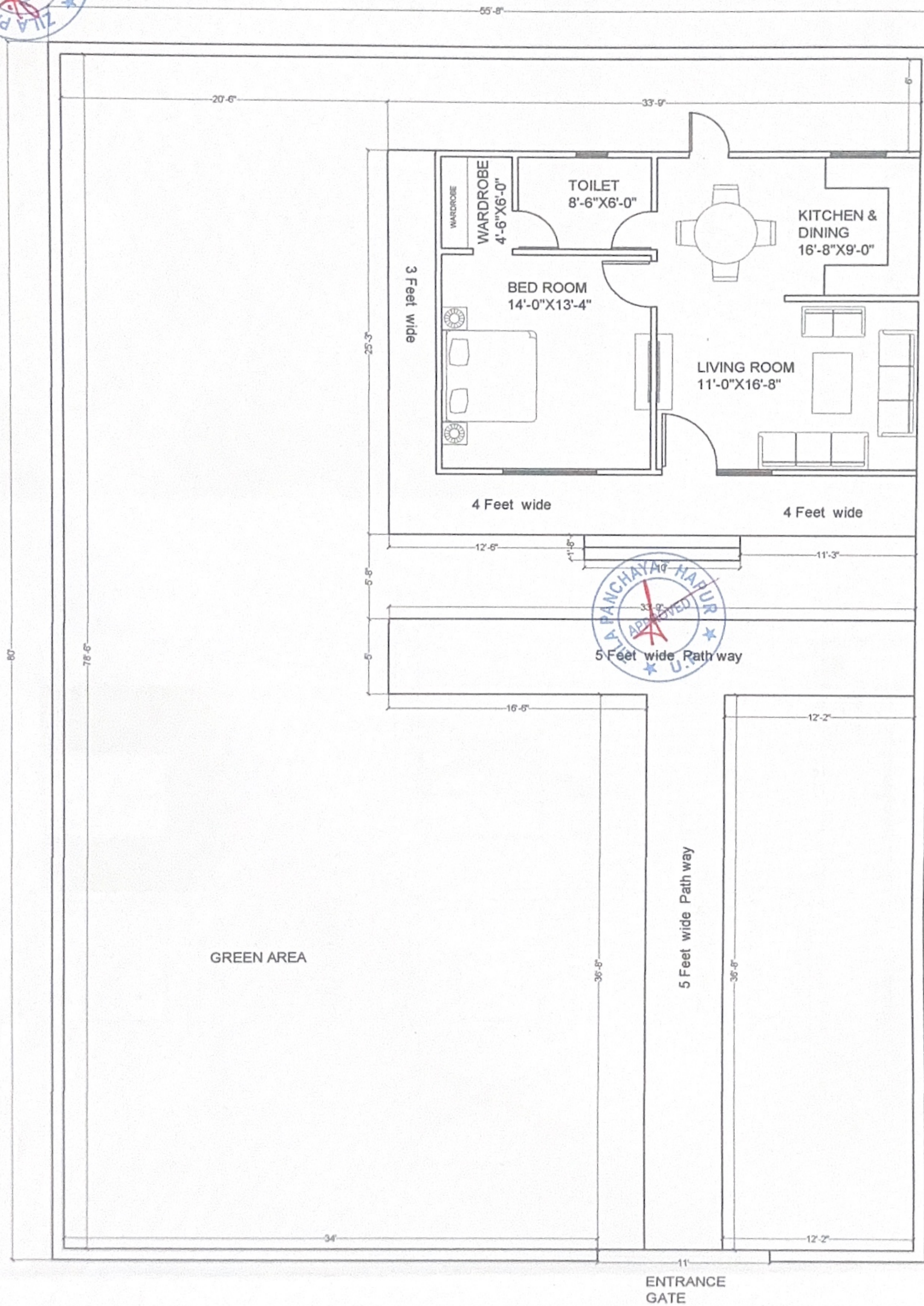

AREA:-
652.55 sqft



Ravi Kumar
Consulting Engineer
Panchayati Raj Department
Hapur UP

REV	DESCRIPTION	DATE	DRN	CHK	APP

PURPOSE OF DRAWING -
Topographical Survey Plan At
GARH MUKTESHWAR

CLIENT:

LOCATION:
GARH MUKTESHWAR

ARCHITECT:
DIVYAKASH ATELIER INC
ARCHITECTURAL . INTERIOR . PLANNING CONSULTANTS
A VENTURE OF DIVYAKASH GROUP
407, ORBIT PLAZA, CROSSING REPUBLIK,
GHAZIABAD
CONTACT US - +91- 9990609559
E mail- groupdivyakash@gmail.com

SHEET TITLE:
1bhk

NAME	DATE	SIGN
DRAWN BY		
CHECKED BY	AD	
APPROVED BY		
PROJECT No.		SHEET SIZE
ISSUE DATE	8.5.20	SCALE
SHEET No.		REV. No.

R 0



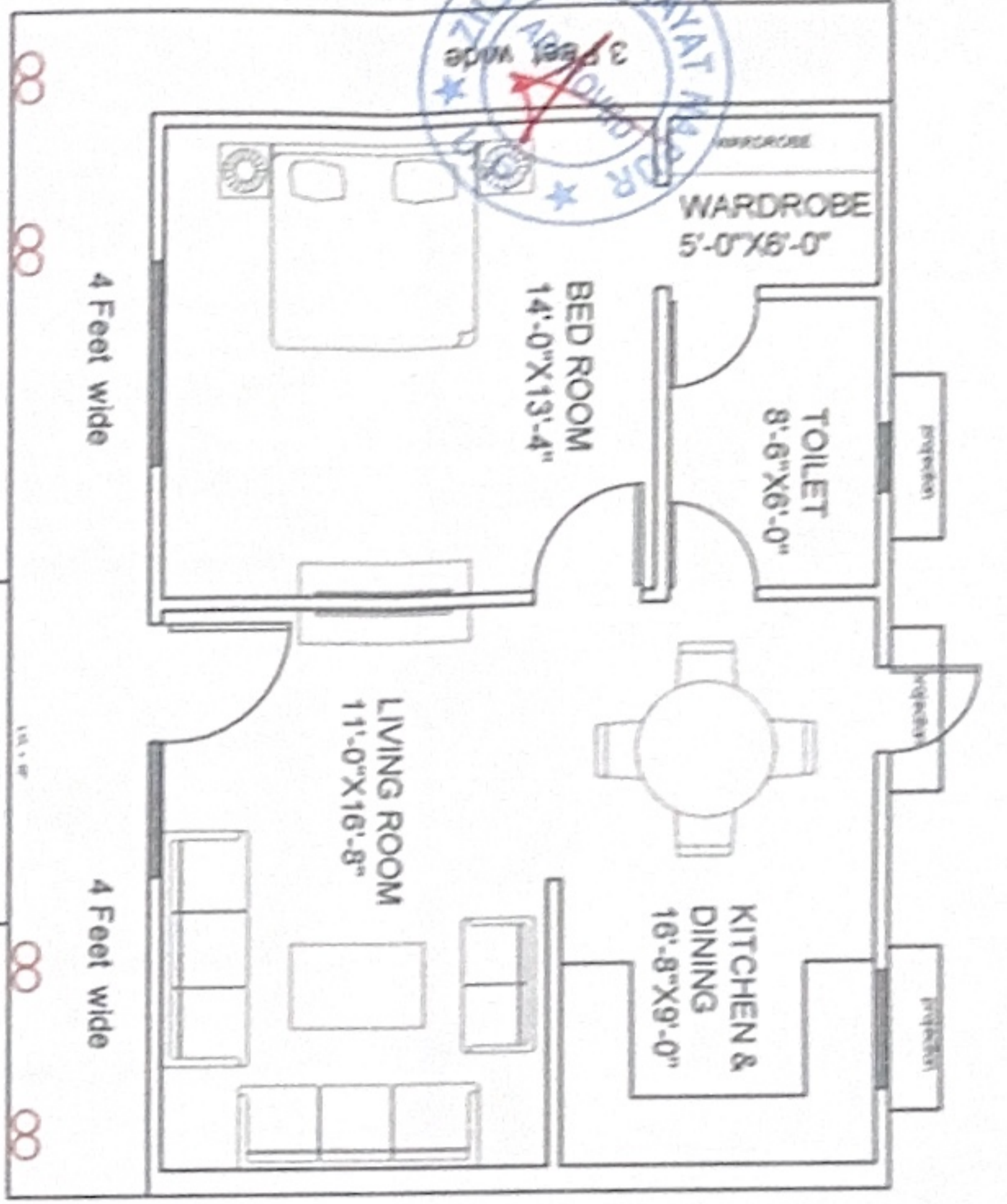

PLAN DETAIL

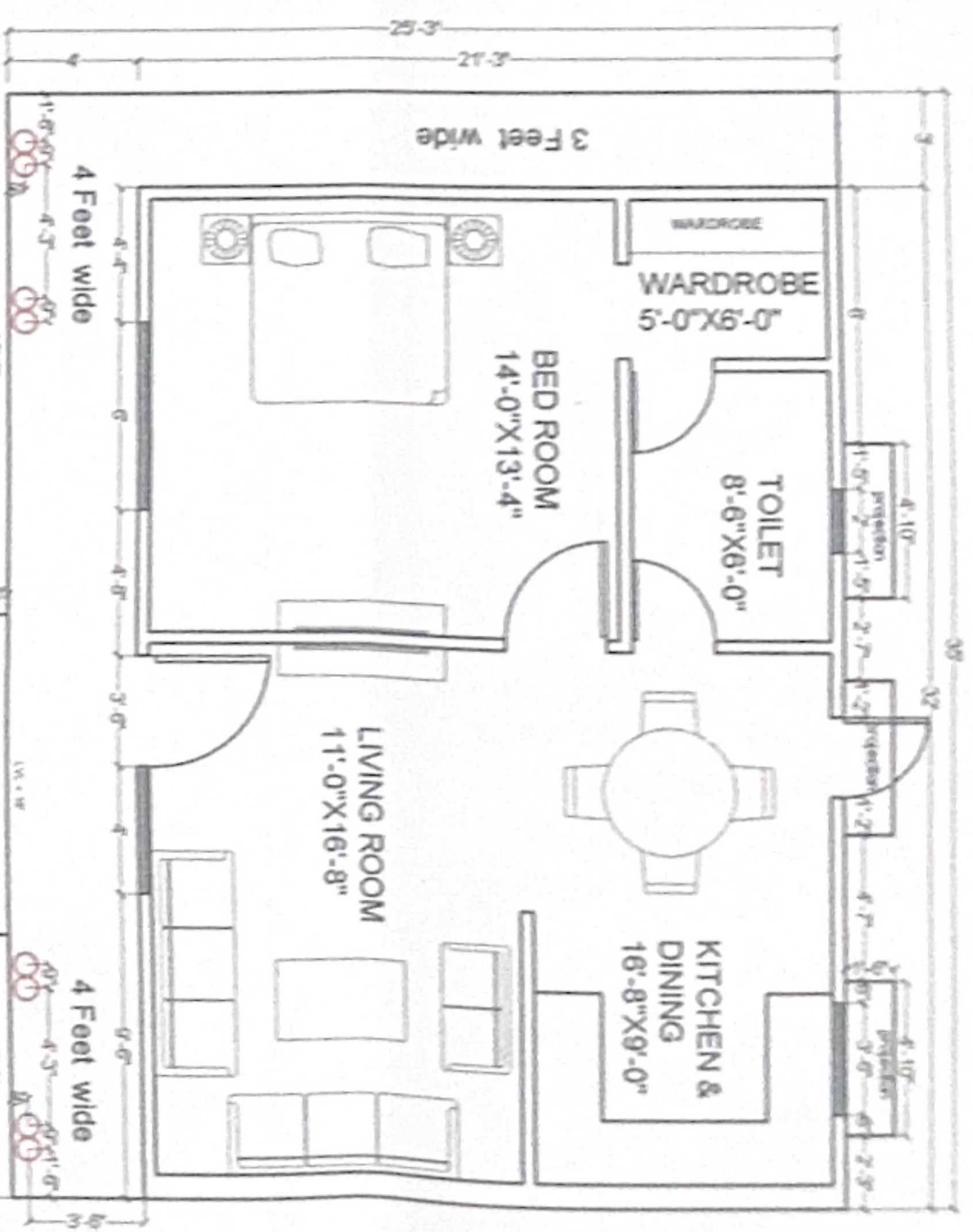

PLAN DETAIL

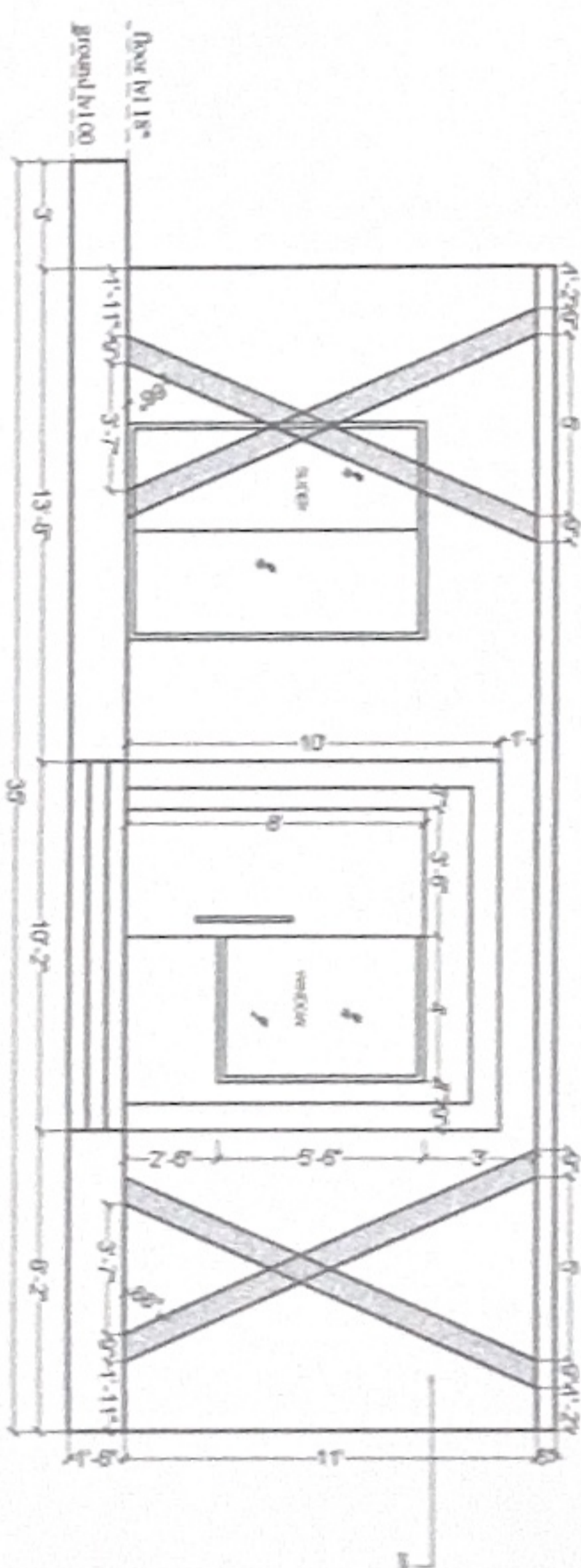

ELEVATION

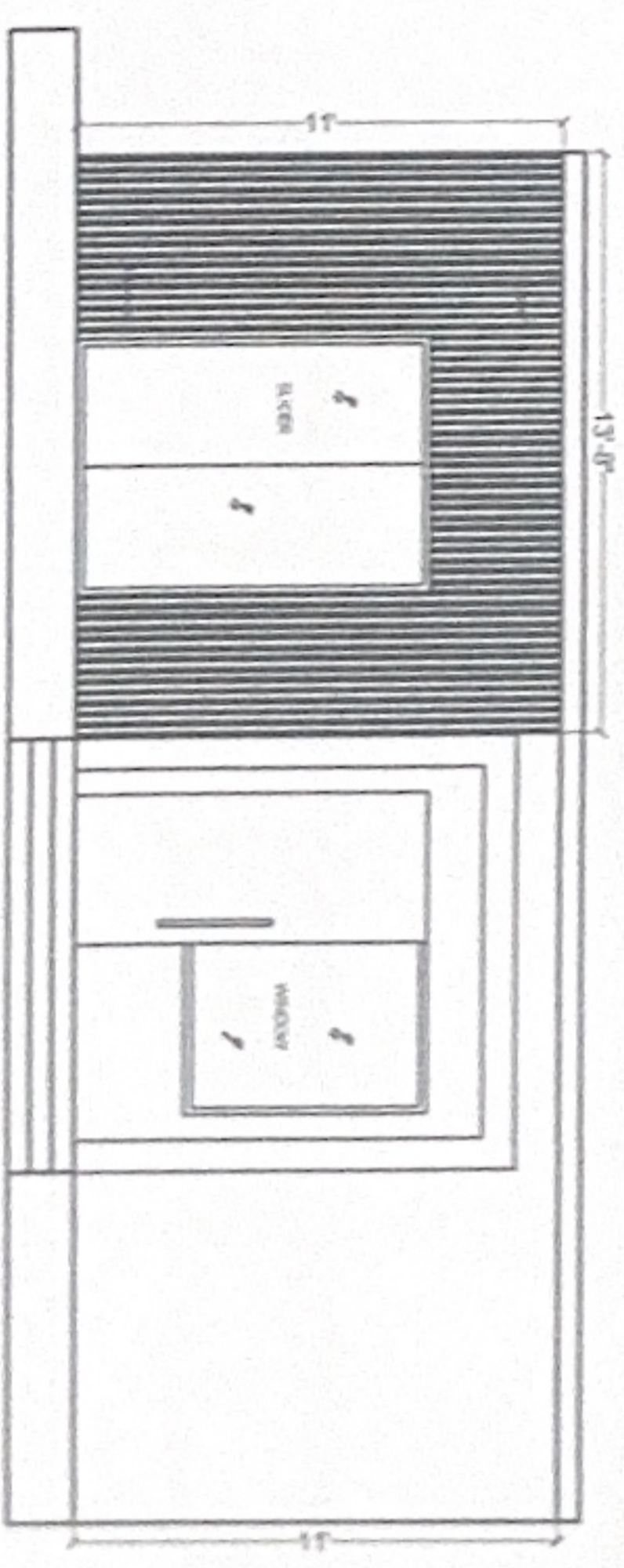

ELEVATION



Divyakash Group
ARCHITECTURAL, INTERIOR, PLUMBING CONSULTANTS

NOTES:
1. THIS IS A CONCEPTUAL DRAWING NOT FOR CONSTRUCTION.
2. ALL DIMENSIONS ARE IN FEET AND INCHES.
ONLY NEEDED DIMENSIONS SHALL BE FOLLOWED.

Ravi Kumar
Consulting Engineer
Panchayati Raj Department
Hapur UP

PROJECT TITLE		1 BHK	
CLIENT			
LOCATION			
ADDRESS			
DIVYAKASH ATELIER INC			
ARCHITECTURAL, INTERIOR, PLUMBING CONSULTANTS			
# 407, ORBIT PLAZA, CROSSING REPUBLIC, GHAZIABAD			
CONTACT US - +91-9800099999			
E-mail: group@divyakash.com			
DATE	DATE	DATE	DATE
DESIGNED BY	CHECKED BY	DATE	DATE
PROJECT NO.	DWG NO.	SCALE	SHEET NO.
115	115	1:1	11
SCALE			DATE
A4			R 0



Divyakash Group
ARCHITECTURAL INTERIOR PLANNING CONSULTANTS

KEY PLAN

NORTH

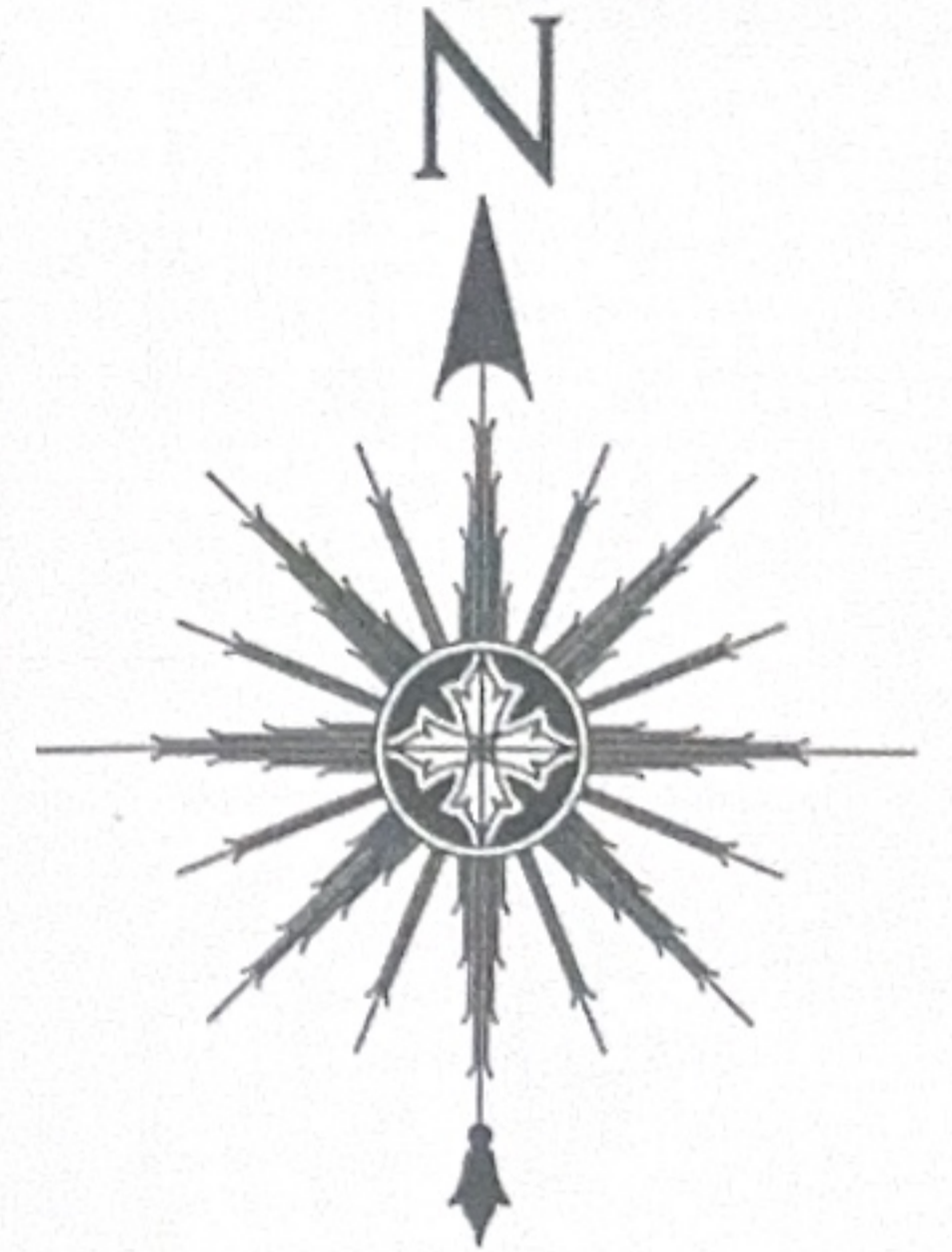

NOTES:-

- 1. THIS IS A CONCEPTUAL DRAWING NOT FOR CONSTRUCTION
- 2. ALL DIMENSIONS ARE IN FT.INCH
- ONLY NOTED DIMENSION SHALL BE FOLLOWED.

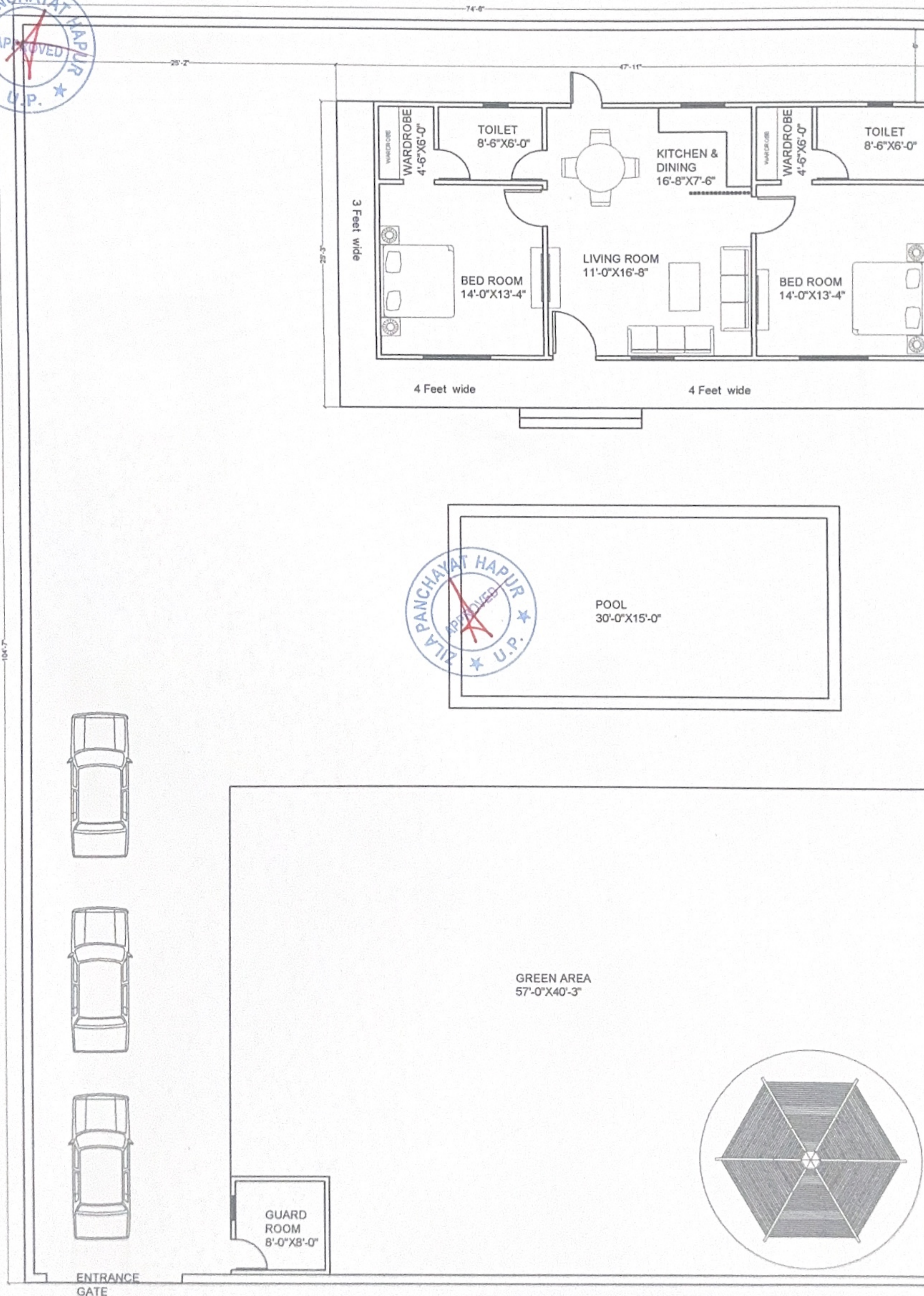

REV	DESCRIPTION	DATE	DSH	DRN	CHK	APP
-----	-------------	------	-----	-----	-----	-----

PURPOSE OF DRAWING :-
Topographical Survey Plan At
GARH MUKTESHWAR

CLIENT

LOCATION
GARH MUKTESHWAR

ARCHITECT
DIVYAKASH ATELIER INC
 ARCHITECTURAL INTERIOR PLANNING CONSULTANTS
 A VENTURE OF DIVYAKASH GROUP
 2407, ORBIT PLAZA, CROSSING REPUBLIK,
 GHAZIABAD
 CONTACT US - +91- 9999609559
 E mail- groupdivyakash@gmail.com



SHEET TITLE
2bhk

NAME	DATE	SIGN
DRAWN BY		
CHECKED BY	AD	
APPROVED BY		
PROJECT No.		SHEET SIZE A3
ISSUE DATE	05.25	SCALE N.T.S.
SHEET No.		REV. No. R0

AREA:-
953.59 sqft

NOTES:-
1. THIS IS A CONCEPTUAL DRAWING NOT FOR CONSTRUCTION
2. ALL DIMENSIONS ARE IN FEET AND INCHES
3. ONLY NORTH DIMENSION SHALL BE FOLLOWED.

PLAN

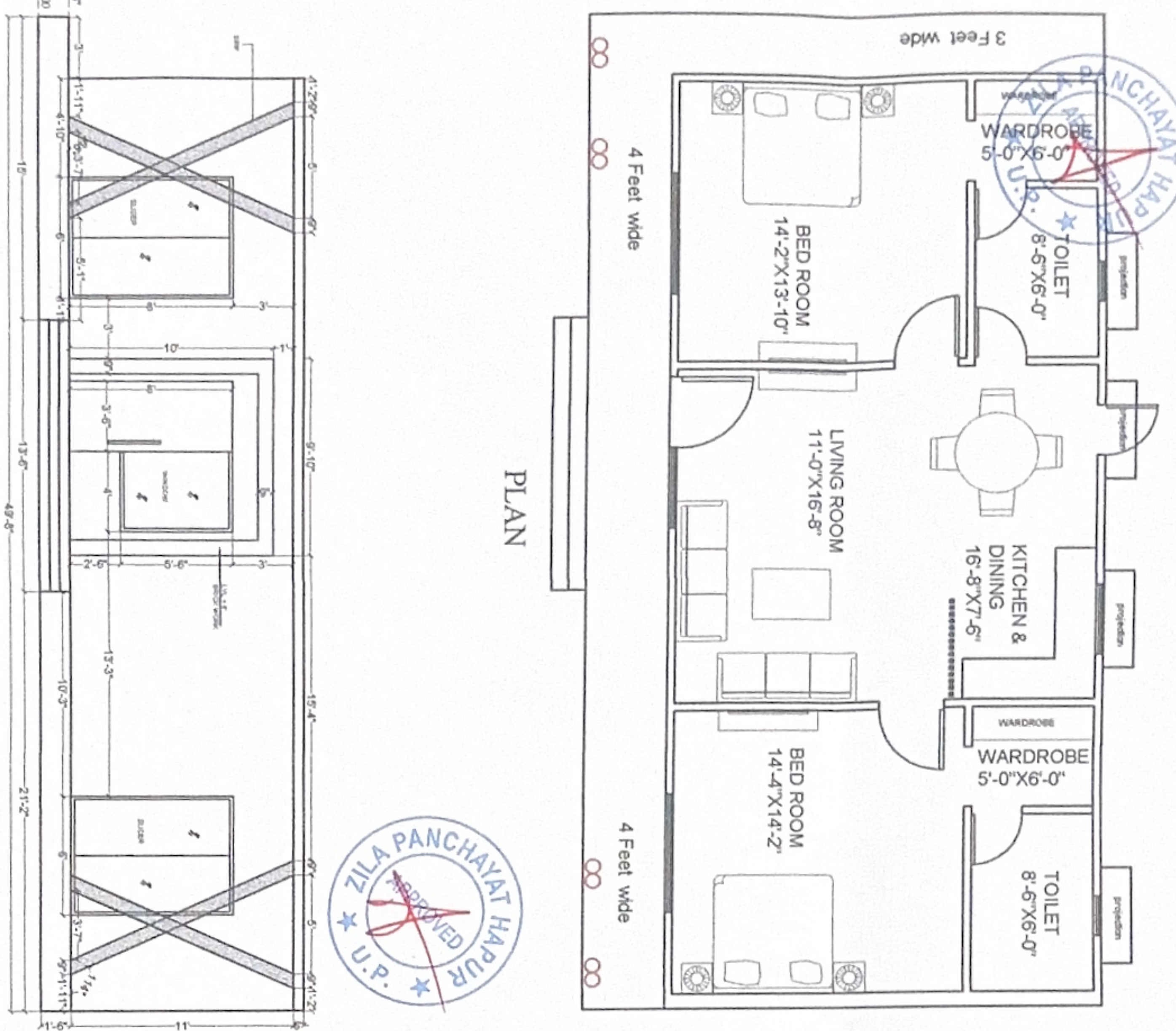

PLAN DETAIL

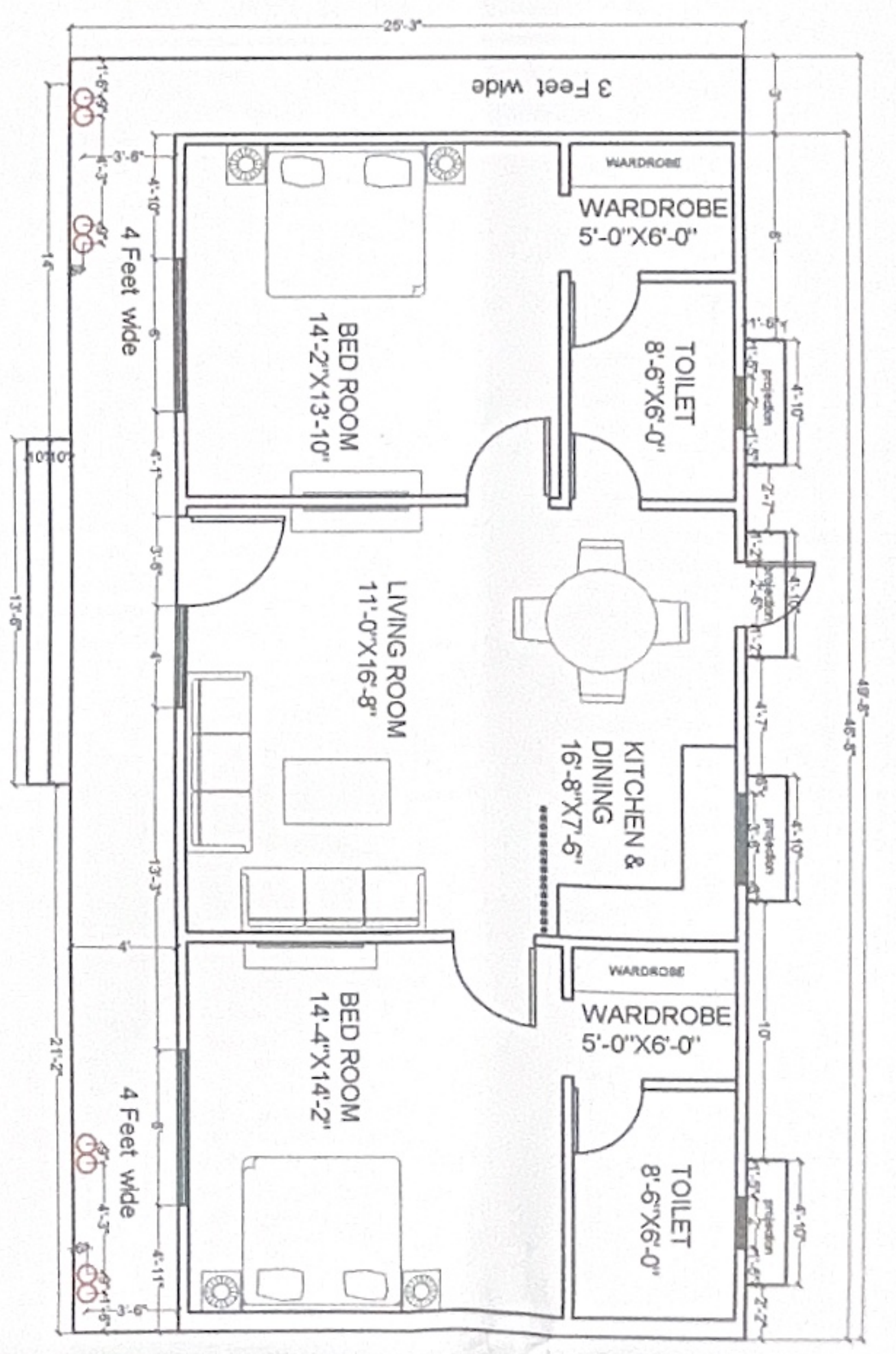

ELEVATION

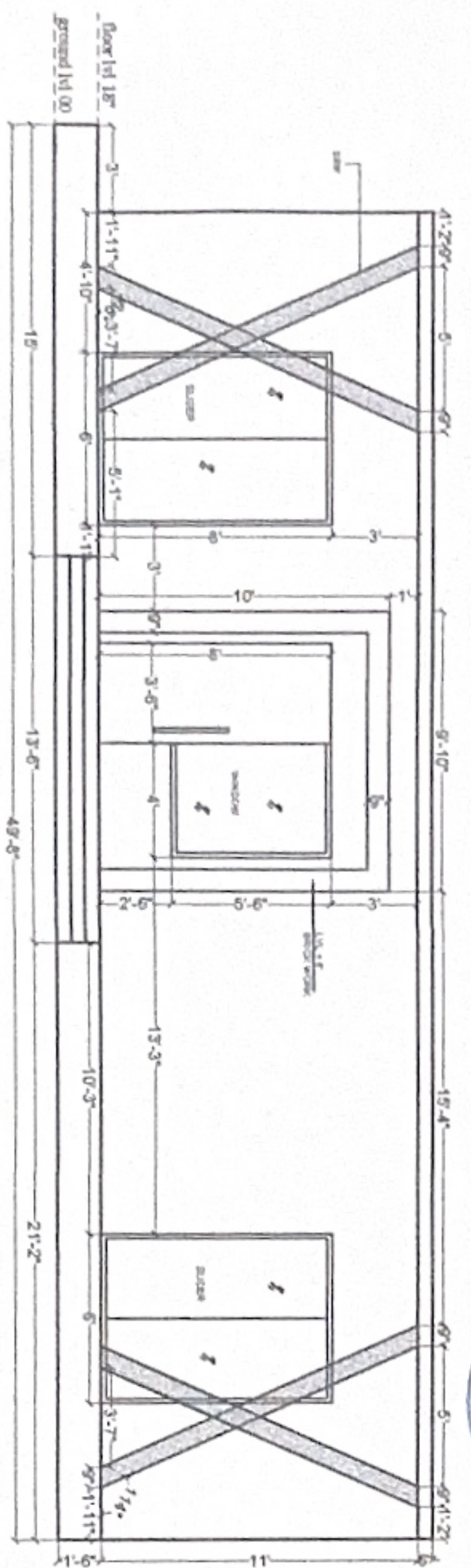

ELEVATION

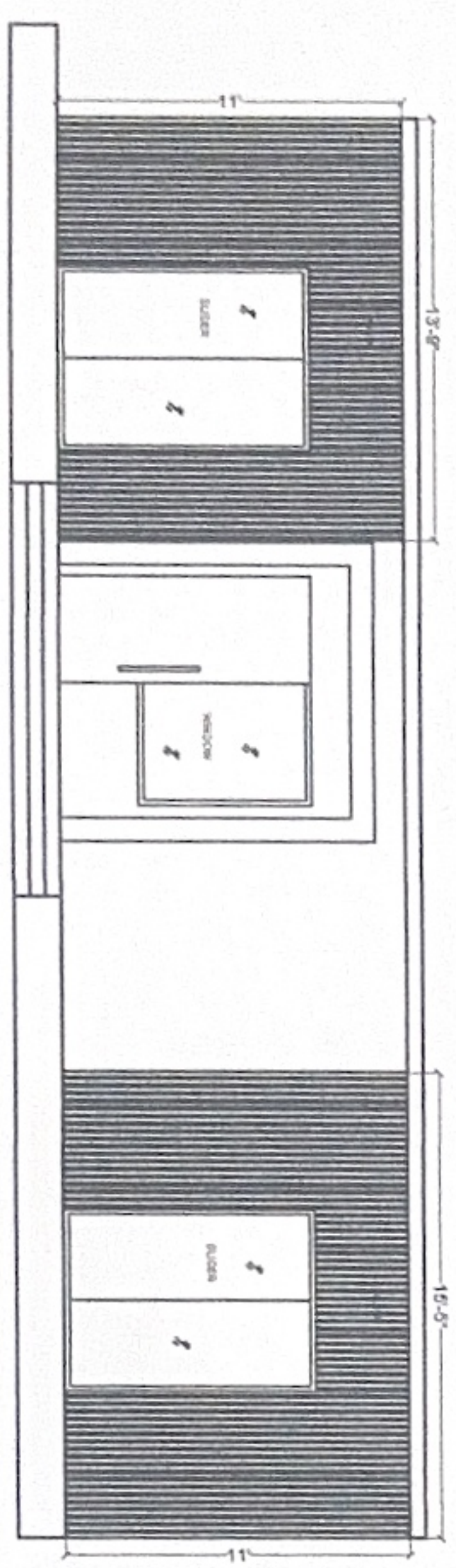

Raw Kumar
Consulting Engineer
Panchayati Raj Department
Hapur U.P.

CLIENT:
GARH MUKTESHWAR

ADDRESS:
DIVYAKASH ATELIER INC
ARCHITECTURAL, INTERIOR PLANNING CONSULTANTS
AVENUE OF DIVYAKASH GROUP
407 ORBIT PLAZA CROSSING NEPAULIK
GHANZHUAD
CONTACT US : 91 869909599
E mail: group@divyakash.com

SHEET TITLE:
2BHK

NO.	REVISION	DATE	BY	CHKD.

STRUCTURE DRAWING

DATE OF DRAWING	
SCALE	
PROJECT NO.	
DWG NO. / V. NO.	
SHEET NO.	
TITLE	
DATE	
BY	
CHKD.	
APPROVED BY	
CHECKED BY	
DRAWN BY	
SCALE	
DATE	
BY	
CHKD.	
APPROVED BY	
CHECKED BY	
DRAWN BY	
SCALE	
DATE	
BY	
CHKD.	
APPROVED BY	
CHECKED BY	
DRAWN BY	
SCALE	
DATE	
BY	
CHKD.	
APPROVED BY	
CHECKED BY	
DRAWN BY	
SCALE	
DATE	
BY	
CHKD.	
APPROVED BY	
CHECKED BY	
DRAWN BY	
SCALE	
DATE	
BY	
CHKD.	
APPROVED BY	
CHECKED BY	
DRAWN BY	
SCALE	
DATE	
BY	
CHKD.	
APPROVED BY	
CHECKED BY	
DRAWN BY	
SCALE	
DATE	
BY	
CHKD.	
APPROVED BY	
CHECKED BY	
DRAWN BY	
SCALE	
DATE	
BY	
CHKD.	
APPROVED BY	
CHECKED BY	
DRAWN BY	
SCALE	
DATE	
BY	
CHKD.	
APPROVED BY	
CHECKED BY	
DRAWN BY	
SCALE	
DATE	
BY	
CHKD.	
APPROVED BY	
CHECKED BY	
DRAWN BY	
SCALE	
DATE	
BY	
CHKD.	
APPROVED BY	
CHECKED BY	
DRAWN BY	
SCALE	
DATE	
BY	
CHKD.	
APPROVED BY	
CHECKED BY	
DRAWN BY	
SCALE	
DATE	
BY	
CHKD.	
APPROVED BY	
CHECKED BY	
DRAWN BY	
SCALE	
DATE	
BY	
CHKD.	
APPROVED BY	
CHECKED BY	
DRAWN BY	
SCALE	
DATE	
BY	
CHKD.	
APPROVED BY	
CHECKED BY	
DRAWN BY	
SCALE	
DATE	
BY	
CHKD.	
APPROVED BY	
CHECKED BY	
DRAWN BY	
SCALE	
DATE	
BY	
CHKD.	
APPROVED BY	
CHECKED BY	
DRAWN BY	
SCALE	
DATE	
BY	
CHKD.	
APPROVED BY	
CHECKED BY	
DRAWN BY	
SCALE	
DATE	
BY	
CHKD.	
APPROVED BY	
CHECKED BY	
DRAWN BY	
SCALE	
DATE	
BY	
CHKD.	
APPROVED BY	
CHECKED BY	
DRAWN BY	
SCALE	
DATE	
BY	
CHKD.	
APPROVED BY	
CHECKED BY	
DRAWN BY	
SCALE	
DATE	
BY	
CHKD.	
APPROVED BY	
CHECKED BY	
DRAWN BY	
SCALE	
DATE	
BY	
CHKD.	
APPROVED BY	
CHECKED BY	
DRAWN BY	
SCALE	
DATE	
BY	
CHKD.	
APPROVED BY	
CHECKED BY	
DRAWN BY	
SCALE	
DATE	
BY	
CHKD.	
APPROVED BY	
CHECKED BY	
DRAWN BY	
SCALE	
DATE	
BY	
CHKD.	
APPROVED BY	
CHECKED BY	
DRAWN BY	
SCALE	
DATE	
BY	
CHKD.	
APPROVED BY	
CHECKED BY	
DRAWN BY	
SCALE	
DATE	
BY	
CHKD.	
APPROVED BY	
CHECKED BY	
DRAWN BY	
SCALE	
DATE	
BY	
CHKD.	
APPROVED BY	
CHECKED BY	
DRAWN BY	
SCALE	
DATE	
BY	
CHKD.	
APPROVED BY	
CHECKED BY	
DRAWN BY	
SCALE	
DATE	
BY	
CHKD.	
APPROVED BY	
CHECKED BY	
DRAWN BY	
SCALE	
DATE	
BY	
CHKD.	
APPROVED BY	
CHECKED BY	
DRAWN BY	
SCALE	
DATE	
BY	
CHKD.	
APPROVED BY	
CHECKED BY	
DRAWN BY	
SCALE	
DATE	
BY	
CHKD.	
APPROVED BY	
CHECKED BY	
DRAWN BY	
SCALE	
DATE	
BY	
CHKD.	
APPROVED BY	
CHECKED BY	
DRAWN BY	
SCALE	
DATE	
BY	
CHKD.	
APPROVED BY	
CHECKED BY	
DRAWN BY	
SCALE	
DATE	
BY	
CHKD.	
APPROVED BY	
CHECKED BY	
DRAWN BY	
SCALE	
DATE	
BY	
CHKD.	
APPROVED BY	
CHECKED BY	
DRAWN BY	
SCALE	
DATE	
BY	
CHKD.	
APPROVED BY	
CHECKED BY	
DRAWN BY	
SCALE	
DATE	
BY	
CHKD.	
APPROVED BY	
CHECKED BY	
DRAWN BY	
SCALE	
DATE	
BY	
CHKD.	
APPROVED BY	
CHECKED BY	
DRAWN BY	
SCALE	
DATE	
BY	
CHKD.	
APPROVED BY	
CHECKED BY	
DRAWN BY	
SCALE	
DATE	
BY	
CHKD.	
APPROVED BY	
CHECKED BY	
DRAWN BY	
SCALE	
DATE	
BY	
CHKD.	
APPROVED BY	
CHECKED BY	
DRAWN BY	
SCALE	
DATE	
BY	
CHKD.	
APPROVED BY	
CHECKED BY	
DRAWN BY	
SCALE	
DATE	
BY	
CHKD.	
APPROVED BY	
CHECKED BY	
DRAWN BY	
SCALE	
DATE	
BY	
CHKD.	
APPROVED BY	
CHECKED BY	
DRAWN BY	
SCALE	
DATE	
BY	
CHKD.	
APPROVED BY	
CHECKED BY	
DRAWN BY	
SCALE	
DATE	
BY	
CHKD.	
APPROVED BY	
CHECKED BY	
DRAWN BY	
SCALE	
DATE	
BY	
CHKD.	
APPROVED BY	
CHECKED BY	
DRAWN BY	
SCALE	
DATE	
BY	
CHKD.	
APPROVED BY	
CHECKED BY	
DRAWN BY	
SCALE	
DATE	
BY	
CHKD.	
APPROVED BY	
CHECKED BY	
DRAWN BY	
SCALE	
DATE	
BY	
CHKD.	
APPROVED BY	
CHECKED BY	
DRAWN BY	
SCALE	
DATE	
BY	
CHKD.	
APPROVED BY	
CHECKED BY	
DRAWN BY	
SCALE	
DATE	
BY	
CHKD.	
APPROVED BY	
CHECKED BY	
DRAWN BY	
SCALE	
DATE	
BY	
CHKD.	
APPROVED BY	
CHECKED BY	
DRAWN BY	
SCALE	
DATE	
BY	
CHKD.	
APPROVED BY	
CHECKED BY	
DRAWN BY	
SCALE	
DATE	
BY	
CHKD.	
APPROVED BY	
CHECKED BY	
DRAWN BY	
SCALE	
DATE	
BY	
CHKD.	
APPROVED BY	
CHECKED BY	
DRAWN BY	
SCALE	
DATE	
BY	
CHKD.	
APPROVED BY	
CHECKED BY	
DRAWN BY	
SCALE	
DATE	
BY	
CHKD.	
APPROVED BY	
CHECKED BY	
DRAWN BY	
SCALE	
DATE	
BY	
CHKD.	
APPROVED BY	
CHECKED BY	
DRAWN BY	
SCALE	
DATE	
BY	
CHKD.	
APPROVED BY	
CHECKED BY	
DRAWN BY	
SCALE	
DATE	
BY	
CHKD.	
APPROVED BY	
CHECKED BY	
DRAWN BY	
SCALE	
DATE	
BY	
CHKD.	
APPROVED BY	
CHECKED BY	
DRAWN BY	
SCALE	
DATE	
BY	
CHKD.	
APPROVED BY	
CHECKED BY	
DRAWN BY	
SCALE	
DATE	
BY	
CHKD.	
APPROVED BY	
CHECKED BY	
DRAWN BY	
SCALE	
DATE	
BY	
CHKD.	
APPROVED BY	
CHECKED BY	
DRAWN BY	
SCALE	
DATE	
BY	
CHKD.	
APPROVED BY	
CHECKED BY	
DRAWN BY	
SCALE	
DATE	
BY	
CHKD.	
APPROVED BY	
CHECKED BY	
DRAWN BY	
SCALE	
DATE	
BY	
CHKD.	
APPROVED BY	
CHECKED BY	